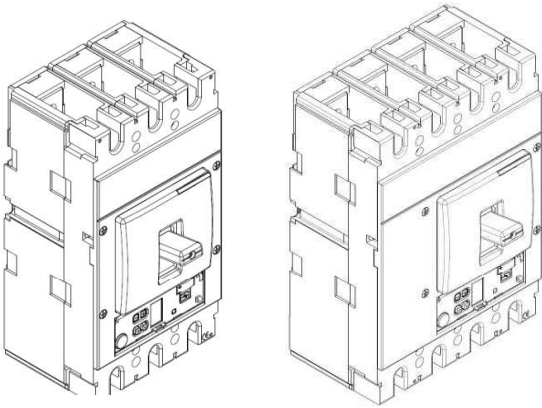

DPX³ 630

Electronic release

 Reference(s) : from 422 056 to 422 215 and
 from 422 498 to 422 537

CONTENTS

	PAGES
1. USE	1
2. RANGE	1
3. DIMENSIONS	1
4. OVERVIEW	2
5. ELECTRICAL AND MECHANICAL CHARACTERISTICS	2
6. CONFORMITY	3
7. EQUIPMENTS AND ACCESSORIES	3
8. CURVES AND TABLES	6

1. USE

DPX³ "moulded case" circuit breaker offers optimal solutions to answer to protection requirements of tertiary and industrial installations.

2. RANGE

I _n (A)	S1 36kA		S2 36kA		S2 + measure 36kA		Sg 36kA		Sg + measure 36kA			
	3P	4P	3P	4P	3P	4P	3P	4P	3P	4P		
250	422498	422503	422056	422061	422096	422101	422136	422141	422176	422181		
320	422499	422504	422057	422062	422097	422102	422137	422142	422177	422182		
400	422500	422505	422058	422063	422098	422103	422138	422143	422178	422183		
500	422501	422506	422059	422064	422099	422104	422139	422144	422179	422184		
630	422502	422507	422060	422065	422100	422105	422140	422145	422180	422185		
50kA												
I _n (A)	3P		4P		3P		4P		3P		4P	
	3P	4P	3P	4P	3P	4P	3P	4P	3P	4P	3P	4P
250	422508	422513	422066	422071	422106	422111	422146	422151	422186	422191		
320	422509	422514	422067	422072	422107	422112	422147	422152	422187	422192		
400	422510	422515	422068	422073	422108	422113	422148	422153	422188	422193		
500	422511	422516	422069	422074	422109	422114	422149	422154	422189	422194		
630	422512	422517	422070	422075	422110	422115	422150	422155	422190	422195		
70kA												
I _n (A)	3P		4P		3P		4P		3P		4P	
	3P	4P	3P	4P	3P	4P	3P	4P	3P	4P	3P	4P
250	422518	422523	422076	422081	422116	422121	422156	422161	422196	422201		
320	422519	422524	422077	422082	422117	422122	422157	422162	422197	422202		
400	422520	422525	422078	422083	422118	422123	422158	422163	422198	422203		
500	422521	422526	422079	422084	422119	422124	422159	422164	422199	422204		
630	422522	422527	422080	422085	422120	422125	422160	422165	422200	422205		
100kA												
I _n (A)	3P		4P		3P		4P		3P		4P	
	3P	4P	3P	4P	3P	4P	3P	4P	3P	4P	3P	4P
250	422528	422533	422086	422091	422126	422131	422166	422171	422206	422211		
320	422529	422534	422087	422092	422127	422132	422167	422172	422207	422212		
400	422530	422535	422088	422093	422128	422133	422168	422173	422208	422213		
500	422531	422536	422089	422094	422129	422134	422169	422174	422209	422214		
630	422532	422537	422090	422095	422130	422135	422170	422175	422210	422215		

3. DIMENSIONS

Implantation

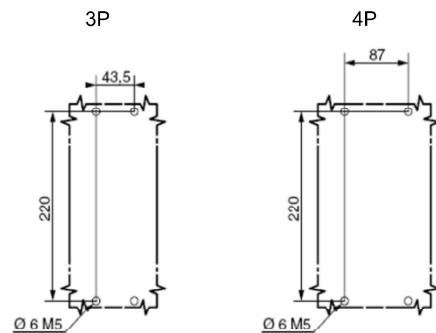

3. DIMENSIONS (NEXT)

Front terminals

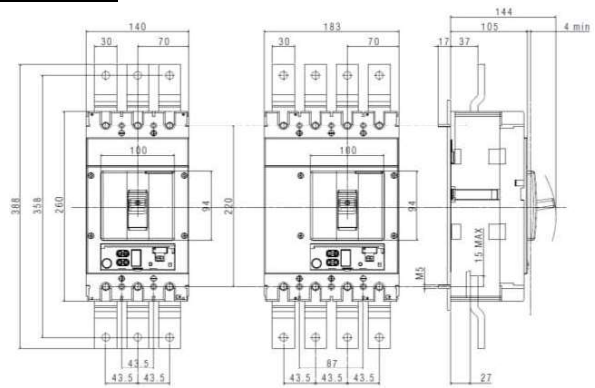

Plug-in version, rear terminals

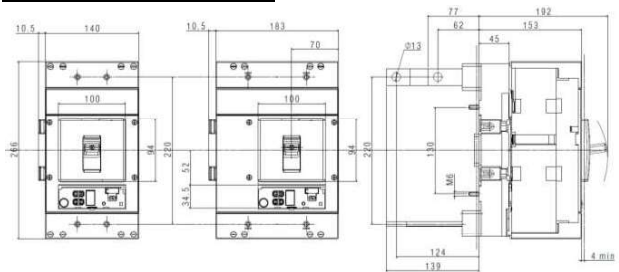

Draw-out version with automatic auxiliary contacts

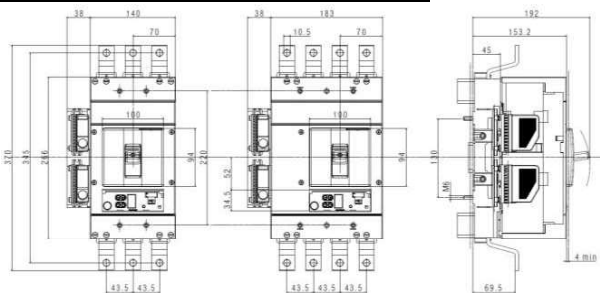

DPX³ 630

Electronic release

Reference(s) : from 422 056 to 422 215 and
from 422 498 to 422 537

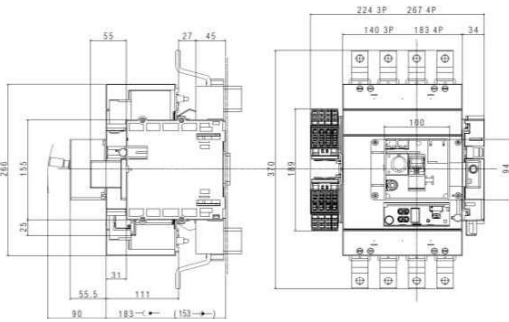

4. OVERVIEW

4.1 Supplied

Connection plates for bars:

- Width 32mm max

Seals for adjustment (supplied)

4.2 Mounting possibility

On plate:

- Vertical
- Horizontal
- Supply inverter type

5. ELECTRICAL AND MECHANICAL CHARACTERISTICS

Circuit breaker	DPX ³ 630 F/N/H/L
Uninterrupted nominal current I_n (A)	250 - 320 - 400 - 500 - 630
Short time admissible current I_{cw} (kA) (for 0.5s)	5 (up to 400A)
Isolated voltage U_i (V AC)	800
Maximum rated operating voltage U_e (V AC)	690
Rated impulse withstand voltage U_{imp} (kV)	8
Nominal frequency (Hz)	50 - 60
Operating temperature (°C)	-25 ÷ 70
Mechanical endurance (cycles)	20000
Mechanical endurance with motor control (cycles)	10000
Electrical endurance (cycles)	4000
Electrical endurance at 0.5 I_n (cycles)	8000
Category of use	B (up to 400A) and A (for 500A and 630A)
Type of trip	electronic
Electronic trip S1	yes
Electronic trip S2	yes
Electronic trip Sg	yes
Thermal adjustment (I_t)	(0.4 - 1) × I_n
Magnetic adjustment (I_{m0})	(1.5 ± 10) × I_n
Neutral adjustment S1	(0, 0.5, 1) × I_n
Neutral adjustment S2, Sg ⁽¹⁾	(0, 0.5, 1, 1.5, 2) × I_n
Dimensions (W x H x D) (mm)	140 x 260 x 105 (3P) 183 x 260 x 105 (4P)
Weight (kg)	4.5 (3P) - 6.4 (4P)

⁽¹⁾: for 1.5 × I_n and 2 × I_n regulation must not exceed I_n .

5.1 Breaking capacity (kA)

U_e/I_{cu}	Breaking capacity (kA) and I_{cs}			
	F	N	H	L
220/240 V AC	70	100	120	150
380/415 V AC	36	50	70	100
440/460 V AC	30	40	60	70
480/500 V AC	25	30	40	50
600 V AC	20	22	25	28
690 V AC	14	18	20	22
I_{cs} (% I_{cu})	100	100	100	70
Rated making capacity under short circuit I_{cm}				
I_{cm} (kA) at 415V	75.6	105	154	220

5.2 Nominal current (I_n) up to 50°C

I_n (A)	Assigned current trip	
	thermal	
	L1 - L2 - L3	N
250	250	0 - 125 - 250 - 375 - 500
320	320	0 - 160 - 320 - 480 - 640
400	400	0 - 200 - 400 - 600 - 800
500	500	0 - 250 - 500 - 750 - 1000
630	630	0 - 315 - 630 - 945 - 1260

5.3 Power losses per pole under I_n

I_n (A)	Power losses (W)									
	250		320		400		500		630	
Pole	Phase	Neutral	Phase	Neutral	Phase	Neutral	Phase	Neutral	Phase	Neutral
Cage terminals	7.5	7.5	12.3	12.3	19.2	19.2	22.1	22.1	35.0	35.0
Lugs	7.5	7.5	12.3	12.3	19.2	19.2	22.1	22.1	35.0	35.0
External lugs	8.2	8.2	13.5	13.5	21.1	21.1	25.1	25.1	39.8	39.8
Spreaders	9.0	9.0	14.7	14.7	22.9	22.9	26.7	26.7	42.3	42.3
Rear terminals	8.7	8.7	14.2	14.2	22.3	22.3	26.9	26.9	42.7	42.7
Plug-in version	15.0	15.0	24.7	24.7	38.5	38.5	52.3	52.3	83.0	83.0
Circuit breaker + RCD	10.6	10.6	17.4	17.4	27.2	27.2	34.6	34.6	54.9	54.9

Total power losses has calculated as the sum of losses of every accessory installed

5.4 Functioning in particular conditions

5.4.1 Temperature

°C	Influence of ambient temperature		
	Up to 50	60	70
I_n (A)	250	225	200
	320	288	256
	400	360	320
	500	450	400
	630	567	536

For derating temperature with other configuration, see table A.

5.4.2 Altitude

Altitude (m)	2000	3000	4000	5000
U_e (V)	690	590	520	460
I_n (A)	I_n	0.98 × I_n	0.93 × I_n	0.9 × I_n

5.4.3 Use at 400Hz

Not possible with electronic release.

5.5 ELECTRONIC RELEASES

5.5.1 Version S1 - Adjustment of I_r , I_{sd}

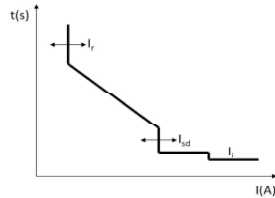
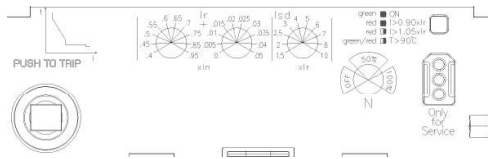

Long delay protection against overloads with an adjustable threshold bases on the RMS value of the current:

- $I_r = 0.4 \div 1 I_n$ (steps 1A)

Short delay protection against short-circuits with an adjustable I_{sd} threshold:

- $I_{sd} = 1.5 - 2 - 2.5 - 3 - 4 - 5 - 6 - 7 - 8 - 9 - 10 \times I_r$ (11 steps)

Instantaneous protection with fixed threshold : $I_i = 5kA$

5.5.2 Version S2 - Adjustment of I_r , T_r , I_{sd} , T_{sd}

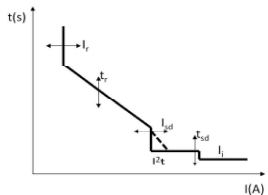
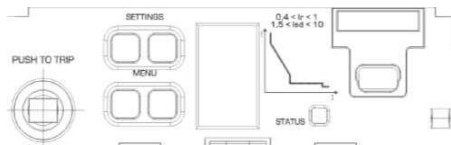

Long delay protection against overloads with an adjustable threshold bases on the RMS value of the current:

- $I_r = 0.4 \div 1 I_n$ (steps 1A)
- $T_r = 3 - 30s$ (3 - 5 - 10 - 15 - 20 - 25 - 30) (7 steps)

Short delay protection against short-circuits with an adjustable I_{sd} threshold:

- $I_{sd} = 1.5 - 2 - 2.5 - 3 - 4 - 5 - 6 - 7 - 8 - 9 - 10 \times I_r$ (11 steps)
- $T_{sd} = 0 - 100 - 200 - 300 - 400 - 500$ ms ($I = K$)
- $T_{sd} = 0 - 100 - 200 - 300 - 400 - 500$ ms ($I^2t = K$)

Instantaneous protection with fixed threshold $I_i = 5kA$

5.5.3 Version Sg – Adjustment of I_r , T_r , I_{sd} , T_{sd} , I_g , T_g

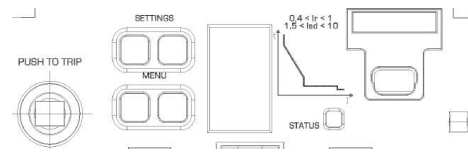

LCD display with adjustment buttons, battery case and USB port.

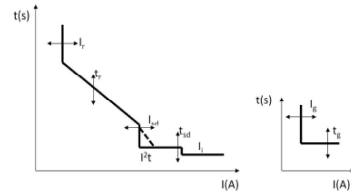

Long delay protection against overloads with an adjustable threshold bases on the RMS value of the current:

- $I_r = 0.4 \div 1 I_n$ (steps 1A)
- $T_r = 3 - 30s$ (3 - 5 - 10 - 15 - 20 - 25 - 30) (7 steps)

Short delay protection against short-circuits with an adjustable I_{sd} threshold :

- $I_{sd} = 1.5 - 2 - 2.5 - 3 - 4 - 5 - 6 - 7 - 8 - 9 - 10 \times I_r$ (11 steps)
- $T_{sd} = 0 - 100 - 200 - 300 - 400 - 500$ ms ($I = K$)
- $T_{sd} = 0 - 100 - 200 - 300 - 400 - 500$ ms ($I^2t = K$)

Instantaneous protection with fixed threshold $I_i = 5kA$

Measure of ground fault:

- $I_g : 0.2 - 0.3 - 0.4 - 0.5 - 0.6 - 0.7 - 0.8 - 0.9 - 1 \times I_n$ (9 steps) and OFF
- $T_g : 0.1 - 0.2 - 0.3 - 0.4 - 0.5 - 1$ s

DPX³ 630

Electronic release

Reference(s) : from 422 056 to 422 215 and
from 422 498 to 422 537

6. CONFORMITY

DPX³ range of product concerning circuit-breakers are in full compliance with the EN/IEC standard 60947-2.

The certificate are issued by LOVAG and/or by IECEE CB-scheme certification scheme.

All the product range are CE, CCC, EAC, ANCE marked.

DPX³ are full in compliance with the Shipping Register of Lloyds, RINA, Bureau Veritas, Germanische Lloyds, Norske Veritas and ABS.

6.1 MARKING



" Tropical climate " :

- execution II (all climates) according to guide UTE C63100

7. EQUIPMENTS AND ACCESSORIES

7.1 Earth leakage modules

Earth leakage characteristics for DPX ³ 630		
	Standard	with Led
Type	A - S	A - S
Uninterrupted nominal current I _n (A)	up to 630	up to 630
Rated isolated voltage U _i (V AC)	500	500
Rated operating voltage U _e (V AC) (50-60Hz)	500	500
Operating voltage (V AC) (50-60Hz)	230 ÷ 500	110 ÷ 500
Nominal frequency (Hz)	50 - 60	50 - 60
Operating temperature (°C)	-25 ÷ 70	-25 ÷ 70
Trip	electronic	electronic
Earth leakage time adjustments (s)	0 - 0.3 - 1 - 3	0 - 0.3 - 1 - 3
Earth leakage breaking capacity I _{dm} (% I _{cu})	60	60
Earth leakage protection adjustments I _{dm} (A)	0.03 ÷ 3	0.03 ÷ 3
Side-by-side mounting	no	no
Underneath mounting	yes	yes
50% Earth fault detection contact I _{dm}	no	yes
Clip on rail DIN 35	no	no
Dimensions (W x H x D) (mm) for 4P	183 x 152 x 105	183 x 152 x 106

(For power losses, see table 5.3)

Standard		
400A	3P	ref. 0 260 60
	4P	ref. 0 260 61
630A	3P	ref. 0 260 64
	4P	ref. 0 260 65
LED version		
400A	4P	ref. 0 260 63
630A	4P	ref. 0 260 67

7.2 Releases

- shunt releases (Power consumption = 300 VA) with voltage
 - 24 V AC and DC ref. 4 222 39
 - 48 V AC and DC ref. 4 222 40
 - 110 V AC and DC ref. 4 222 41
 - 230 V AC and DC ref. 4 222 42
 - 400 V AC and DC ref. 4 222 43

- undervoltage releases (Power consumption = 5 VA) with voltage
 - 24 V DC ref. 4 222 44
 - 24 V AC ref. 4 222 45
 - 48 V DC ref. 4 222 46
 - 110 V AC ref. 4 222 47
 - 230 V AC ref. 4 222 48
 - 400 V AC ref. 4 222 49

- time-lag undervoltage releases (800 ms)

Time-lag modules with voltage

- 24 V AC and DC ref. 0 261 92
- 230 V AC ref. 0 261 90
- 400 V AC ref. 0 261 91
- Universal Release ref. 4 226 23

7.3 Auxiliary contact

Changeover switch 3A – 250 VAC

ref. 4 210 11

To show the state of the contacts or opening of the DPX³ on a fault:

Auxiliary contact (standard) **C**
Fault signal **S**

Auxiliary contact		
Nominal voltage (V _n)	V (AC or DC)	24 to 250
Intensity (A)	24 V DC	5
	48 V DC	1.7
	110 V DC	0.5
	230 V DC	0.25
	110 V AC	4
	230/250 V AC	3

Configurations:

DPX³ 630 → 2 auxiliary contact + 1 fault signal + 1 release

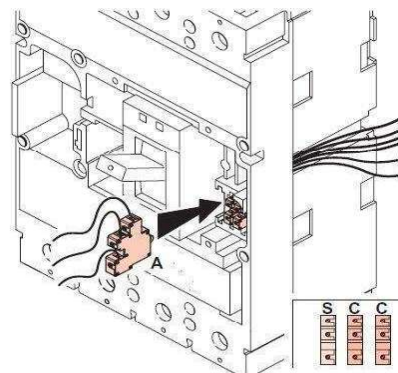

DPX³ 630

Electronic release

Reference(s) : from 422 056 to 422 215 and
from 422 498 to 422 537

7.4 Rotary handles

Direct on DPX³

- Standard (black) ref. 0 262 41
- For emergency use (red / yellow) adapting on standard handle ref. 4 222 38

Vari-depth handle IP55

- Standard (black) ref. 0 262 81
- For emergency use (red / yellow) adapting on standard handle ref. 0 262 82

Locking accessories

- Profalux type (cod.HBA90GPS6149) for vari-depth handle ref. 0 262 93
- Ronis type (cod.ABA90GEL6149) for vari-depth handle ref. 0 262 94

7.5 Motor-driven handles

Front operated

- Voltage 24 V AC and DC ref. 0 261 40
- Voltage 48 V AC and DC ref. 0 261 41
- Voltage 230 V AC ref. 0 261 44

Locking accessories

- Ronis type (cod.ABA90GEL6149) ref. 0 261 59
- Profalux type (cod.HBA90GPS6149) ref. 0 261 58

7.6 Mechanical accessories

Insulated shields

- Set of 3 ref. 0 262 30

Sealable terminal shields

- Set of 2 3P ref. 0 262 44
- Set of 2 4P ref. 0 262 45

Terminal covers to guarantee IP20

- Set of 2 3P ref. 4 222 34
- Set of 2 4P ref. 4 222 35

Padlocks

- Accessories to lock in open position ref. 0 262 40

7.7 Connection accessories

Cage terminals

- Set of 4 terminals for cables 300mm² max (rigid) or 240mm² max (flexible) Cu/Al ref. 0 262 50
- Set of 4 terminals for cables 2x240mm² max (rigid) or 2x180mm² max (flexible) Cu/Al ref. 0 262 51

Extended front terminals

- Set of 4 ref. 0 262 47

Spreaders

- Set of 3 (incoming or outgoing 3P) ref. 0 262 48
- Set of 4 (incoming or outgoing 4P) ref. 0 262 49

Rear terminals

(use to connect fixed version with front terminals into fixed version with rear terminals)

- Set of swivel terminals, incoming or outgoing
 - 3P ref. 0 263 50
 - 4P ref. 0 263 51
- Set of flat rear terminals, incoming or outgoing
 - 3P ref. 0 263 52
 - 4P ref. 0 263 53

7.8 Plug-in version

(A plug-in is a DPX³ fitted with tulip contacts mounted on a base)

Terminals for plug-in & draw-out base

- Set of 6 terminals (3P) ref. 4 222 20
- Set of 8 terminals (4P) ref. 4 222 21

Tulip contact

- Set of tulip contact (supplied with an incoming/outgoing protective cover)

3P ref. 0 265 50
4P ref. 0 265 51

Bases

- front terminal mounting base
 - 3P ref. 4 222 22
 - 4P ref. 4 222 23
- flat rear terminal mounting base
 - 3P ref. 4 222 24
 - 4P ref. 4 222 25

Bases with earth leakage underneath mounting

- front terminal mounting base ref. 4 222 26
- Flat rear terminal mounting base ref. 4 222 27

Accessories

- Set of 2 extractor handles ref. 4 222 28
- Set of connectors (6 pins) ref. 0 098 19
- Set of connectors (24 pins – 3x8 or 2x12) ref. 4 222 29
- Signal contact (plugged-in / drawn-out) ref. 0 265 74

7.9 Draw-out version

(A DPX³ draw-out version is a plug-in DPX³ fitted with a "Débro-lift" mechanism which can be used to withdraw the DPX³ while keeping it on its base)

"Débro-lift" mechanism

- For DPX³ base only
 - 3P ref. 4 222 31
 - 4P ref. 4 222 32
- For DPX³ 4P base with earth leakage module ref. 4 222 33

Key lock for "Débro-lift" mechanism

- For DPX³ only
 - Ronis type (cod.ABA90GEL6149) ref. 0 265 76
 - Profalux type (cod.HBA90GPS6149) ref. 0 263 48
- For motorized DPX³ or with rotary handle
 - Ronis (cod.ABA90GEL6149) ref. 0 265 78
 - Profalux (cod.HBA90GPS6149) ref. 0 265 77

Accessories for "Débro-lift" mechanism

- Isolated handle for drawing-out ref. 0 265 75
- Signal contact (plugged-in / drawn-out) ref. 0 265 74
- Support plate for draw-out version ref. 4 222 36
- Automatic auxiliary contacts (6 pin) for D/O version (2pieces installable max.) ref. 4 222 30

7.10 Supply inverter type

(one plate with interlock for two devices)

- Fixed version ref. 0 264 09
- Plug-in/draw out version ref. 0 264 04

DPX³ 630

Electronic release

Reference(s) : from 422 056 to 422 215 and
from 422 498 to 422 537

7.11 Supply

- Auxiliary supply (input 24 V AC/DC) ref. 4 210 83

7.12 RS485 ModBus communication interface

- To connect electronic DPX³ to an RS485 ModBus communication network ref. 4 210 75

7.13 Web server

- For remote viewing of values collected on electricity meters and multi-function measuring units
 - 32 metering points ref. 0 261 78
 - Unlimited metering points ref. 0 261 79

7.14 Software

- To display values collected on electricity meters and multi-function measuring units on a PC connected to the network
 - 32 metering points ref. 0 261 88
 - Unlimited metering points ref. 0 261 89

7.15 Touch screen

- To show data collected by DX³, DPX³, DMX³, EMDX³. It can manage up to 8 devices ref. 0 261 56

8. CURVES

8.1 TRIPPING CURVE

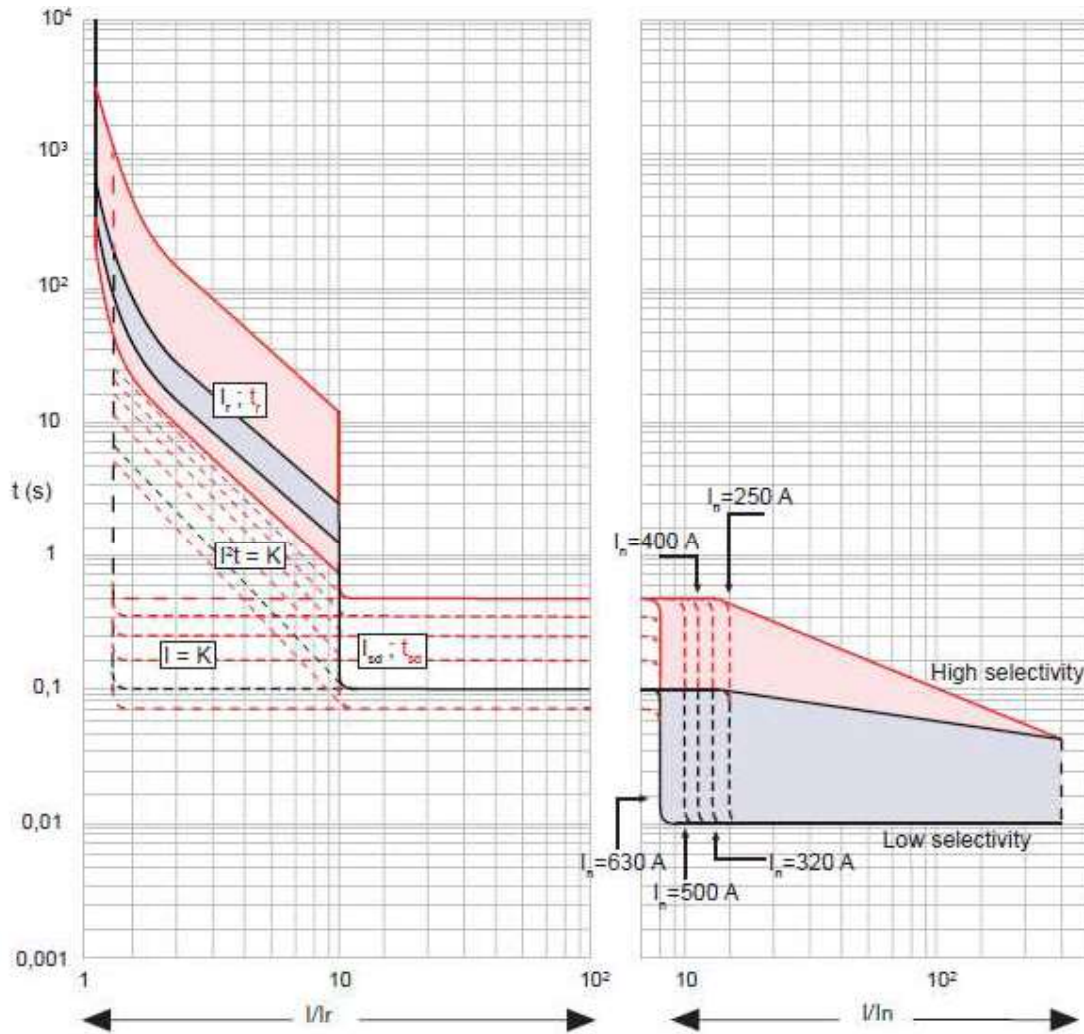

$I_{cu} = 36-50-70-100 \text{ kA}$ $I_{max} = 630\text{A}$ 3-4 P $U_o = 415\text{Vac}$

Value	Description
t	time
I	current
I_n	rated current
I_r	long time setting current
t_r	long time delay
I_{sd}	short time setting current
t_{sd}	short time delay
$I^2t = K$	Constant pass-through energy setting
$I = K$	Constant tripping time setting
Black area	For S1, S2 and Sg versions
Red Area	Only for S2 and Sg versions

8.1 TRIPPING CURVE (NEXT)

Only Sg version

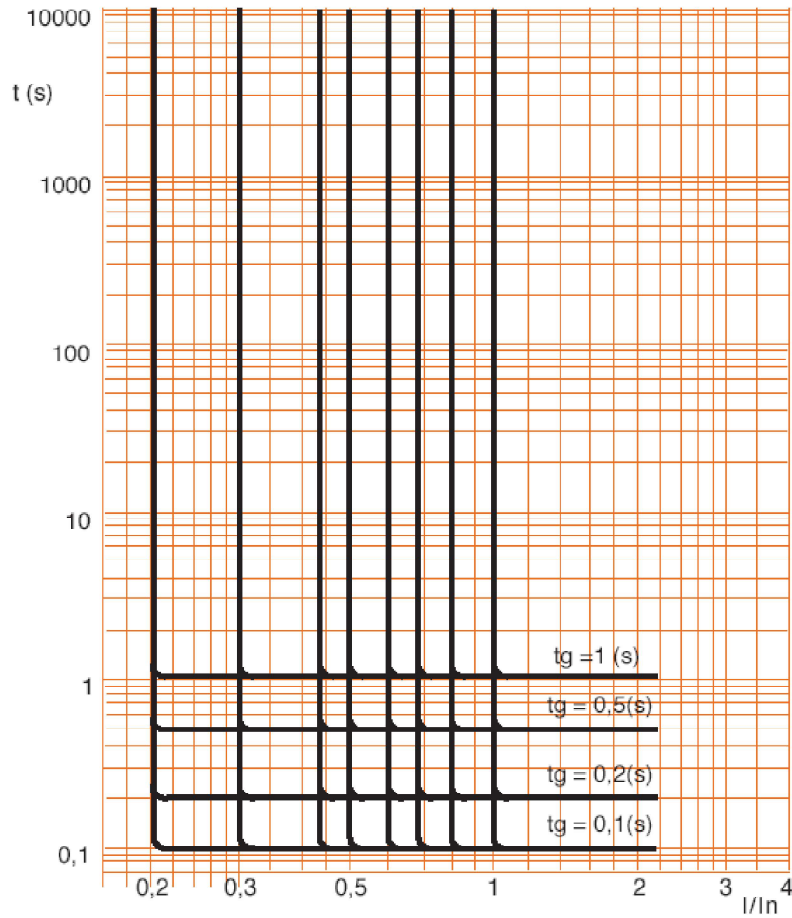

$I_{max} = 630A$ 3-4 P $U_e = 415Vac$

Value	Description
t	time
I	current
I_n	rated current
t_g	Ground fault time delay

8.2 RESTRICTED CURVE IN THERMAL CONSTRAINT

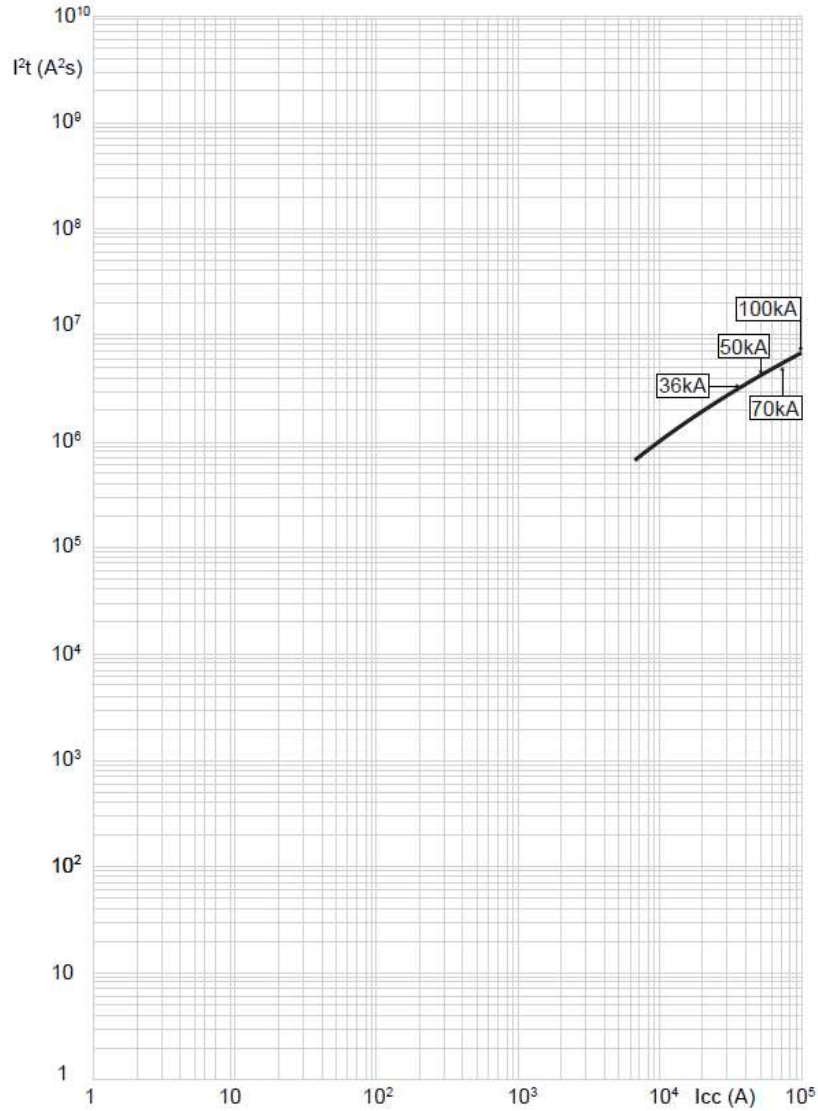

$I_{cu} = 36-50-70-100 \text{ kA}$ $I_{max} = 630A$ 3-4 P $U_o = 415Vac$

Value	Description
I_{cc}	short circuit current
I^2t	pass-through specific energy

8.3 RESTRICTED CURRENT CURVE

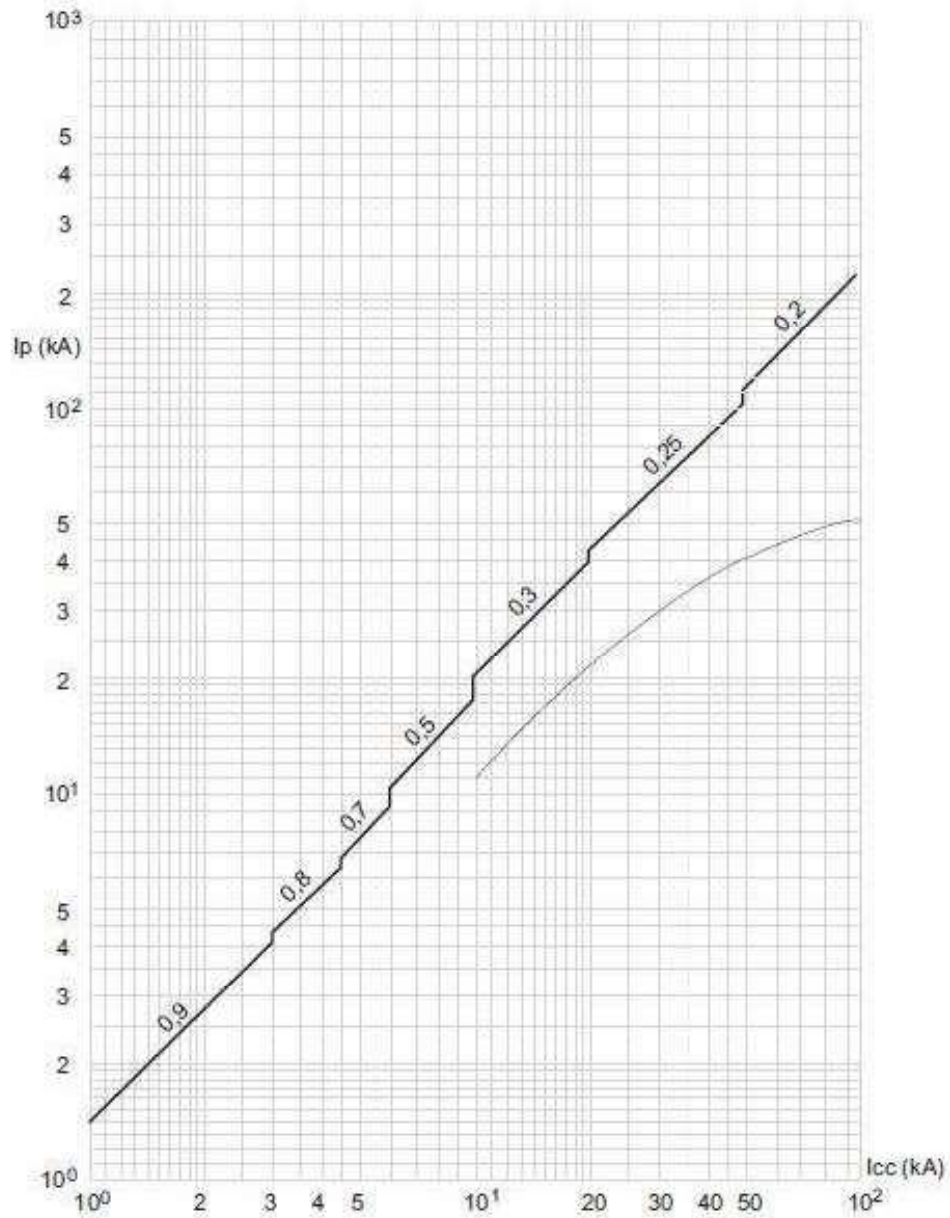

$I_{cu} = 36-50-70-100 \text{ kA}$ $I_{max} = 630\text{A}$ 3-4 P $U_o = 415\text{Vac}$

Value	Description
I_{cc}	short circuit current
I_p	peak current

DPX³ 630

Electronic release

Reference(s) : from 422 056 to 422 215 and
from 422 498 to 422 537

A) Derating Temperature and configurations

		30°C		40°C		50°C		60°C		70°C	
		I _{max} (A)	I _r / I _n	I _{max} (A)	I _r / I _n	I _{max} (A)	I _r / I _n	I _{max} (A)	I _r / I _n	I _{max} (A)	I _r / I _n
DPX ³ 630 fixed	Cage terminals, flexible cable	630	1	630	1	630	1	599	0.95	567	0.9
	Lugs, flexible cable	630	1	630	1	630	1	567	0.9	536	0.85
	Lugs, rigid cable	630	1	630	1	630	1	599	0.95	567	0.9
	Spreaders, flexible cable	630	1	630	1	630	1	536	0.85	504	0.8
	Rear flat staggered terminals, flexible cable	630	1	630	1	630	1	567	0.9	536	0.85
	Rear tang terminals, flexible cable	630	1	599	0.95	599	0.95	504	0.8	473	0.75
DPX ³ 630 fixed + RCD	Cage terminals, flexible cable + RCD	630	1	630	1	536	0.85	504	0.8	473	0.75
	Lugs, flexible cable + RCD	599	0.95	599	0.95	536	0.85	504	0.8	473	0.75
	Lugs, rigid cable + RCD	630	1	599	0.95	536	0.85	504	0.8	473	0.75
	Spreaders, flexible cable + RCD	630	1	630	1	536	0.85	504	0.8	473	0.75
	Rear flat staggered terminals, flexible cable + RCD	630	1	630	1	536	0.85	504	0.8	473	0.75
	Rear tang terminals, flexible cable + RCD	599	0.95	599	0.95	567	0.9	536	0.85	504	0.8

B) Breaking capacity in DC (kA)

Circuit breaker	I _n (A)	1 pole			2 poles in series			3 poles in series				4 poles in series				Protection		
		≤55-60V	≤110-125V	250V	≤110-125V	250V	400V	≤110-125V	250V	400V	500V	Thermal	Magnetic	Earth leakage				
DPX ³ 630 (I _{cu} = 36kA)	250 - 320 - 400	40	40	36	N/A	N/A	40	N/A	N/A	N/A	40	N/A	1.5 I _n AC	not available				
DPX ³ 630 (I _{cu} = 50kA)	250 - 320 - 400	45	45	40	N/A	N/A	45	N/A	N/A	N/A	45	N/A	1.5 I _n AC	not available				
DPX ³ 630 (I _{cu} = 70kA)	250 - 320 - 400	45	45	40	N/A	N/A	45	N/A	N/A	N/A	45	N/A	1.5 I _n AC	not available				
DPX ³ 630 (I _{cu} = 100kA)	250 - 320 - 400	50	50	45	N/A	N/A	50	N/A	N/A	N/A	50	N/A	1.5 I _n AC	not available				
DPX ³ 630 (I _{cu} = 36kA)	500 - 630	40	40	36	N/A	N/A	40	N/A	N/A	N/A	40	N/A	1.5 I _n AC	not available				
DPX ³ 630 (I _{cu} = 50kA)	500 - 630	45	45	40	N/A	N/A	40	N/A	N/A	N/A	40	N/A	1.5 I _n AC	not available				
DPX ³ 630 (I _{cu} = 70kA)	500 - 630	45	45	40	N/A	N/A	45	N/A	N/A	N/A	45	N/A	1.5 I _n AC	not available				
DPX ³ 630 (I _{cu} = 100kA)	500 - 630	50	50	45	N/A	N/A	50	N/A	N/A	N/A	50	N/A	1.5 I _n AC	not available				