

For your safety

Room temperature control unit insert

Operating instructions

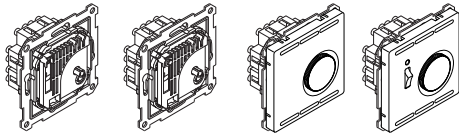

Room temperature control unit insert with changeover contact

Art. no. MTN536400 (230 V)

Room temperature control unit insert with changeover contact

Art. no. MTN536401 (24 V)

Room temperature control unit insert with switch

Art. no. MTN536302 (230 V)

Room temperature control unit insert with switch

Art. no. MTN536304 (24 V)

System design

Room temperature control unit 230 V with switch and central plate

Art. no. MTN5760-60..

Room temperature control unit 24 V with switch and central plate

Art. no. MTN5761-60..

Room temperature control unit 230 V with changeover contact and central plate

Art. no. MTN5762-60..

Room temperature control unit 24 V with changeover contact and central plate

Art. no. MTN5763-60..

Necessary accessories

- To be completed with:
- Central plate for room temperature control unit insert
- Frame in corresponding design

DANGER



Risk of serious damage to property and personal injury, e.g. from fire or electric shock, due to incorrect electrical installation.

Safe electrical installation can only be ensured if the person in question can prove basic knowledge in the following areas:

- Connecting to installation networks
- Connecting several electrical devices
- Laying electric cables

These skills and experience are normally only possessed by skilled professionals who are trained in the field of electrical installation technology. If these minimum requirements are not met or are disregarded in any way, you will be solely liable for any damage to property or personal injury.

CAUTION



The protective insulation conforms to IEC/EN 60730-1 when correctly installed on a level, non-conductive, inflammable surface.

Introduction to the room temperature control unit

The freely mountable electromechanical room temperature control unit insert (referred to as **insert** from here on) is used to control the temperature in dry and enclosed spaces, such as flats, schools, halls, workshops, etc., with normal ambient conditions.

Selecting an installation site

- Installation on interior walls opposite the heat source is preferable.
- Mounting height: approx. 1.5 m above the floor.
- External walls and draughts from windows and doors should be avoided.
- Ensure that the warm air in the room has free access to the insert. To this end, the insert should not be installed inside shelving units or behind curtains and similar coverings.

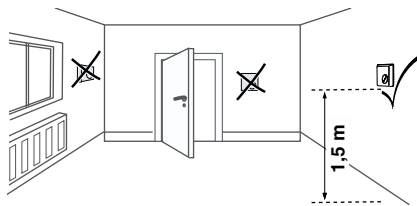

- External sources of heat have a negative effect on the accuracy of the control unit. Therefore, avoid direct sunlight, proximity to televisions, radio and heating appliances, lamps, fireplaces and heating pipes.
- A dimmer generates heat too!
If the insert is installed with a dimmer in a shared switch frame, the two should be as far apart as possible. If they are arranged one on top of the other, the insert must be below the dimmer.

Installing the insert

- 1 Wire the insert according to the corresponding circuit diagram.



Observe the following:

- Ensure that neutral conductor N is connected to terminal N. If it isn't, this will result in significant temperature fluctuations because the insert is not able to work properly.
- When using conductors with a cross-section of 2.5 mm², we recommend using deep installation boxes to make installation easier.
- A protective conductor does not have to be connected as the insert is insulated.
- LED on = insert switched on.

Circuit diagram for insert with switch

MTN5760-60.. / MTN5761-60.. / MTN536302 / MTN536304

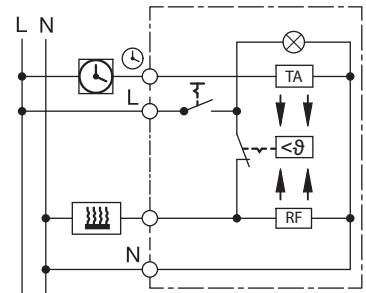

Circuit diagram for insert with changeover contact

MTN5762-60.. / MTN5763-60.. / MTN536400 / MTN536401

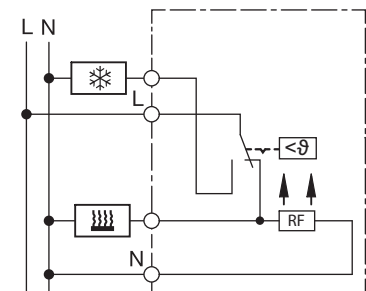

Symbol	Explanation:
L	Outer conductor (phase)
N	Neutral conductor
	Connection for timer signal for temperature reduction
	Load connection for heating
	Load connection for cooling
RF	Resistor for thermal feedback
TA	Resistor for reducing the room temperature at night

② Installing the insert

i To ensure that the insert functions properly, the support ring must always be fitted on a finished wall. It must not be wallpapered over, for example.

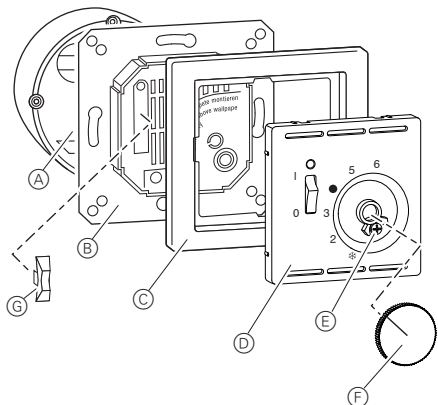

- ③ Insert rocker switch **G** into the switch base (for MTN536302, MTN536304, MTN5760-60.. and MTN5761-60.. only).
- ④ Place frame **C** and central plate **D** on the insert and fasten using screw **E**.
- ⑤ Push on setting knob **F**.

Commissioning the insert

When commissioning the insert, be aware that the bimetallic element needs time to adjust to the room temperature. Therefore the switching point will deviate from the room temperature directly after installation or after night economy is switched off. The switching point becomes accurate after approx. 1 to 2 hours of operating time.

We therefore recommend an initial set temperature that is higher than actually required so that initial heating and initial temperature equalisation are faster. After the temperature has been reached, the temperature setting can be set to the setpoint value required.

Operating the insert

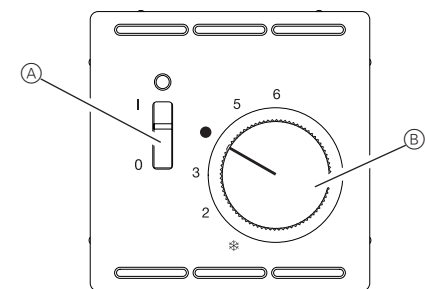

- A** On/off switch (for MTN536302, MTN536304, MTN5760-60.. and MTN5761-60.. only)
- B** Setting knob for temperature preselection

Use the setting knob to set the temperature required. The scale corresponds to a temperature range of approx. 5 to 30°C.

Temperature setting scale with symbols/numbers

	= approx. 5°C		= approx. 20°C
2	= approx. 10°C	5	= approx. 25°C
3	= approx. 15°C	6	= approx. 30°C

Limiting the temperature adjustment range

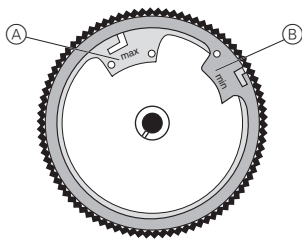

- A** Red ring (max.): highest temperature that can be set
- B** Blue ring (min.): lowest temperature that can be set

The insert is factory-set to a maximum adjustment range of 5 to 30°C.

There are 2 adjusting rings in the setting knob. These can be used to limit the temperature adjustment range within the minimum and maximum values.

Setting procedure

- ① Turn the setting knob to roughly the middle of the required adjustment range.
- ② Remove the setting knob.
- ③ Insert the tip of a ballpoint pen into the hole and turn the ring to the required temperature limit. The red adjusting ring needs to be turned anticlockwise. The blue adjusting ring needs to be turned clockwise.
- ④ Put the setting knob back on.

Technical data

Type:	MTN536302 MTN5760-60..
Special features:	Mains switch Mains light Temperature reduction
Contact:	Break contact
Temperature range:	5-30°C
Nominal voltage:	AC 230 V
Heating nominal current:	10(4) A
Heating switching capacity:	2.2 kW
Differential gap:	~0.5 K
Temperature reduction:	~4 K

Type:	MTN536304 MTN5761-60..
Special features:	Mains switch Mains light Temperature reduction
Contact:	Break contact
Temperature range:	5-30°C
Nominal voltage:	AC 24 V
Heating nominal current:	10(4) A
Heating switching capacity:	240 W
Differential gap:	DC max. 100 W
Temperature reduction:	~0.5 K
Temperature reduction:	~4 K

Type:	MTN536400 MTN5762-60..
Contact:	Changeover contact
Temperature range:	5-30°C
Nominal voltage:	AC 230 V
Nominal current	
Heating:	10(4) A
Cooling:	5(2) A
Switching capacity	
Heating:	2.2 kW
Cooling:	1.1 kW
Differential gap:	~0.5 K

Type:	MTN536401 MTN5763-60..
Contact:	Changeover contact
Temperature range:	5-30°C
Nominal voltage:	AC 24 V
Nominal current	
Heating:	10(4) A
Cooling:	5(2) A
Switching capacity	
Heating:	240 W
Cooling:	DC max. 30 W
Cooling:	120 W
Cooling:	DC max. 30 W
Differential gap:	~0.5 K

Type:	All
Ambient temperature:	0-55°C
Degree of contamination:	2
Rated surge voltage:	4 kV
Voltage and current for EMC emitted interference test purposes:	230 V, 0.1 A
Permitted relative room humidity:	max. 95%, non-condensing
Energy class:	I = 1%
Mode of operation:	1 C
Protection class:	II (once the cover has been fitted)
Connecting terminals:	Plug-in terminals for 1 to 2.5 mm ² solid conductors



Dispose of the device separately from household waste at an official collection point. Professional recycling protects people and the environment against potential negative effects.

Schneider Electric Industries SAS

If you have technical questions, please contact the Customer Care Centre in your country.
schneider-electric.com/contact