



HEATIT WIFI6

 PRODUCT DOCUMENTS 	
Firmware version FW 1.0	Document version 2024-A
Article no. 54 305 41 54 305 42 54 305 43	Document date 02.04.2024

Org. doc. date 02.04.2024

Installers manual



TABLE OF CONTENTS

- | | |
|---|-------------------------------------|
| 1. Introduction | 16. Selecting sensor value |
| 2. Quick start | 17. Calibration |
| 3. Installation disclaimer | 18. Brightness |
| 4. Connections | 19. Display on/off |
| 5. Installation | 20. Display icons |
| 6. Add/Remove | 21. Child lock |
| 7. Factory reset | 22. Open window detection |
| 8. Startup | 23. Error codes |
| 9. Principles of regulation | 24. Safety features |
| 10. Local settings menu | 25. Associations (pending) |
| 11. Display menu structure | 26. Configuration parameters |
| 12. Temperature shown in display | 27. Indicator |
| 13. Standby and main screen | 28. Thermostat dimensions |
| 14. kWh value in menu | 29. Thermostat controls |
| 15. Choice of sensor | 30. Chart - display menu |
- Product info

1. INTRODUCTION

Heatit WiFi6 is an electronic thermostat designed for electrical heating. The thermostat can be controlled using the "MyHeatit" App via Wi-Fi, Bluetooth (BLE), or by the buttons on the front of the thermostat. The thermostat has a user friendly interface.

Heatit WiFi6 has 3 modes; Heat - Cool and Eco.

The thermostat fits in standard European junction boxes and may be used with most System 55 frames. It has a sturdy metal frame for secure fastening on the junction box. The thermostat has a built-in room temperature sensor. Two additional external temperature sensors may also be connected. The device has an open API and supports Amazon Alexa and Google Home (open API, Amazon Alexa and Google Home is pending).

The thermostat can communicate over a local API, where the user can make integration with a local gateway, server, controller that offers such a service.

The installer can configure and set up the system via Bluetooth. After the system is set up, the installer can transfer the property to the customer. The customer can then transfer the system to their Wi-Fi network.

Heatit WiFi6 has active power metering and it gives you real time information about your power consumption. It also allows you to set the power metering value manually in case of connection with a contactor.

The device has implemented ZeroX technology. This technology makes sure the relay switches at 0V when turning on and off. With this technology the thermostat will have a much longer lifetime.

The device can withstand a load of max. 16A/3600W at 230VAC. We recommend a contactor for loads above 13A.

2. QUICK START

Upon connecting the device to power, it will automatically enter add mode for a duration of 60 minutes.

1. Switch off the mains voltage (disable the fuse).
2. Open the junction box.
3. Connect the wires according to the description in chapter "Connections". Optional: Connect external wired sensors.
4. After verifying the connections, switch on the mains voltage.
5. In the "MyHeatit" App, choose "Add Device", enter your Wi-Fi details, search for and select your device.
6. The thermostat will display "INCL" when the thermostat is successfully added.

NB! If adding/removing fails, Err (error) will appear in the display.

GET THE MYHEATIT APP HERE



3. INSTALLATION DISCLAIMER

Installation must be done by a qualified electrician in accordance with national building codes. Before installation, disconnect the power to the device from the mains. During installation of the device, power to the device must be disconnected AT ALL TIMES!

4. CONNECTIONS

Max tightening torque for terminal screws: 2Nm.

If the cable used has multiple strands, using an end sleeve is advised. The product allows for wiring of cables with a cross section of up to 1x2.5mm².

To access the terminal screws, hold the sides of the display and gently pull outwards to detach the front piece.

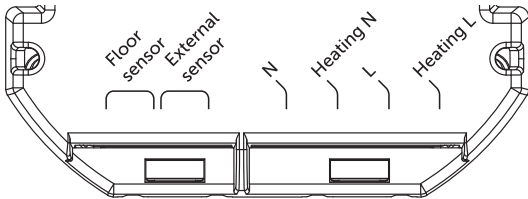

Floor sensor	NTC type 6.8, 10, 12, 15, 22, 33, 47 or 100kΩ. Default 10kΩ.
External sensor	NTC type 6.8, 10, 12, 15, 22, 33, 47 or 100kΩ. Default 10kΩ.
N	Power connection (Neutral) 230VAC.
Heating N	Heating cable N connection.
L	Power connection (Live) 230VAC.
Heating L	Heating cable L connection.

5. INSTALLATION

Position the thermostat and mount it into the junction box using 2 screws. Position the thermostat front over the part mounted in the junction box, then carefully press the front until it clicks into place. In order to get power metering values, the load needs to be connected to both heating L + N.

Never change the front from one thermostat to another.

6. ADD/REMOVE

Please read this before installation

Upon connecting the device to power, it will automatically enter add mode for a duration of 60 minutes. During this time the device can be added to the app without starting add mode locally on the thermostat (skip to step 4 in chapter 6.1)

To remove a device, find the device in the "MyHeatit" App and choose "Delete this device". If the app is unavailable perform a "Factory reset"

6.1 Method 1: Wi-Fi and Bluetooth

Add mode is indicated on the device by rotating LED segments in the display. It indicates this for 90 seconds until a timeout occurs, or until the device has been added to the network. Add mode may also be cancelled by performing the same procedure as for starting add mode.

When adding in Wi-Fi, skip step 4 below.

When adding to Bluetooth, skip step 5 below.

1. Hold the center button for 5 seconds.
The display will show "OFF".
2. Press the "+" button once to see "CON" in the display.
3. Start the add mode on the thermostat by holding the center button for approximately 2 seconds.
4. In the "MyHeatit" App, choose "Add Device", enter your Wi-Fi details, search for your device and select it.
5. In the "MyHeatit" App, choose "Add Device", choose "Add Bluetooth" device, search for your device and select it.

When a device is added to Bluetooth it is not accessible from the internet. You need to be within Bluetooth range of the device to control it.

The device is now ready for use with default settings.

NB! When the device is removed from the "MyHeatit" App, the parameters are reset.

If inclusion fails, please perform a "Factory reset".

6.2 Method 2: QR Code

1. Hold the center button for 5 seconds.
The display will show "OFF".
2. Press the "+" button once to see "CON" in the display.
3. Start the add mode on the thermostat by holding the center button for approximately 2 seconds.
4. In the "MyHeatit" App, "Add Wi-Fi device" or "Add Bluetooth device".
5. Press the QR Code button in the bottom right and scan the QR code on the device.

7. FACTORY RESET

Enter the menu by holding the center button for about 5 seconds, navigate in the menu with the "+" button till you see "FACT". Press the center button until you see "-- --" blinking in the display, then hold for about 5 seconds to perform a reset. You may also initiate a reset by holding the right and center buttons for 60 seconds.

When either of these procedures has been performed, the thermostat will perform a complete factory reset. The device will display "RES" for 5 seconds while performing a factory reset. When "RES" is no longer displayed, the thermostat has been reset.

8. STARTUP

After powering up the device for the first time, all parameters will have default settings and the thermostat will start by asking which sensor mode should be used.

9. PRINCIPLES OF REGULATION

The thermostat uses temperature readings retrieved from the internal sensor and/or from external wired sensors to regulate the temperature. The thermostat will regulate the temperature using hysteresis or PWM, based on the setpoint temperature. To select either "HYST" or "PWM" you can find the "REG" menu option or use Parameter 13 "Regulation mode" ("OPER").

9.1 Hysteresis

Hysteresis will turn on and off the load based on the hysteresis value in comparison to the setpoint. You can make changes to the thermostat hysteresis. You may choose hysteresis values between 0.3°C and 3.0°C using Parameter 14 "Temperature control hysteresis" ("HYST"). The default setting is 0.5°C. When using waterbased heating we recommend a hysteresis of 1.0°C.

You may also change the hysteresis by entering the local settings menu and holding the Center button for 2 seconds when "REG" is displayed. Here you can choose values between 0.3 and 3.0.

9.2 Pulse-width modulation PWM

With PWM regulation enabled, the thermostat will regulate based on duty cycles. The thermostat is turned on and off in percentage intervals of the cycle. The amount of time the relay will be on is based on how far the measured temperature is from the setpoint.

10. LOCAL SETTINGS MENU

To enter the settings menu, hold the Center button for 5 seconds. The display will display "OFF". You are now in the settings menu. While in the settings menu, "SET" will be displayed in the bottom right of the display. You can now scroll up and down using the Left and Right buttons. Some options have submenus. To navigate the submenus, press the Center button once to enter or exit the submenu. Press the Left and Right buttons to find your desired value and hold the Center button for 2 seconds to confirm your selection. "STOR" will appear to indicate settings are stored.

11. DISPLAY MENU STRUCTURE

See flowchart at the end of this manual.

12. TEMPERATURE SHOWN IN DISPLAY

By default, the temperature shown on the display while in standby state is the setpoint. This may be altered with Parameter 15: "Temperature display". It may also be changed by entering the local settings menu and holding the Center button for 2 seconds when "MODE" is displayed. You can choose between "SETT" and "RELT". "SETT" is the Setpoint temperature and "RELT" is the real-time temperature.

13. STANDBY AND MAIN SCREEN

When the thermostat remains untouched for a while, it will automatically go to the standby screen. The standby will by default show the setpoint temperature.

By pressing any button once, you will see the measured temperature. By pressing the Left or Right button multiple times, you will change the setpoint.

14. KWH VALUE IN MENU

The device supports power metering to give insight into the power consumption of the heating. The total consumption of the device can be seen in the system from the "kWh" menu option. The total consumption data can be reset by holding the Center button while in the kWh menu.

SIZE OF LOAD

In the "load" menu or from Parameter 26 "Size of load", the load value can be set manually if the load is not directly connected to the thermostat. The size of load can be adjusted in 100W increments up to 9900W.

15. CHOICE OF SENSOR

The thermostat has multiple sensors and sensor modes. This lets you configure the thermostat to work correctly in most installations. The sensors and modes may be selected from either the local settings menu or via Parameter 2; "Sensor mode" ("OPER").

Available sensor modes:

F	Floor sensor
A	Internal room sensor
AF	Internal room sensor + Floor sensor
A2	External room sensor
A2F	External room sensor + Floor sensor
PWER	Power regulator mode (no sensor used)

NOTE: Some types of floor require that a floor sensor is connected in order to limit the floor temperature to a maximum of 27°C (check the manual from the floor manufacturer). When the thermostat is used in (AF or A2F) the floor limiter FHI is automatically set to 27°C. When using any other sensor type (A, F or A2) the minimum and maximum limits are 5°C and 40°C respectively.

16. SELECTING SENSOR VALUE

The thermostat allows the selection of multiple different resistance values of an NTC sensor and can be selected using either the local settings menu or via Parameter 3: "Sensor value" ("SEN"). The supported sensor values are as follows: 6.8, 10, 12, 15, 22, 33, 47 or 100kΩ.

The factory default value is 10kΩ. When connecting both the floor sensor and the external sensor, make sure to use sensors with the same Ohm value.

17. CALIBRATION

If the temperature sensor readout is not correct, you can make minor changes to the temperature readout. The temperature readings can be calibrated by $\pm 6^\circ\text{C}$ using Parameter 10, 11 and 12. The calibration can also be performed from the menu using CAR, CAE and CAF. The adjusted value will be displayed in the app indicating what the thermostat uses for regulation.

SENSOR TYPE	IN MENU STRUCTURE	PARAMETER
Internal sensor	CAR	10
External sensor	CAE	11
Floor sensor	CAF	12



18. BRIGHTNESS

Using the menu choices "BR1" and "BR2", the brightness of the display in Active and Standby state can be changed respectively. "BR1" and "BR2" are also included in the device as Parameter 16 "Active display brightness" ("BR1") and Parameter 17 "Standby display brightness" ("BR2").

19. DISPLAY ON/OFF (DON/DOFF)

The thermostat has a display ON/OFF function which decides whether the display should turn completely off when in Standby. To enable/disable this function, hold the Left and Center buttons for 10 seconds. The display will show "DOFF" when the function is activated and "DON" when the function is disabled. When operating any button, the display will light up.

20. DISPLAY ICONS

ICON	DESCRIPTION
	This icon will be displayed while the relay is on and the thermostat is in either Heating or Eco mode.
	This icon will be displayed while the relay is on and the thermostat is in Cooling mode.
	This icon shows the current signal strength.

21. CHILD LOCK

Child lock is a function for disabling the buttons from the display locally. It will show "LOCK" when attempting to operate it while the function is enabled. To enable or disable the function, hold the Left and Right buttons for 10 seconds. Enabling the function will show "LOCK" in the display, disabling the function will show "OPEN".

22. OPEN WINDOW DETECTION OWD

Open Window Detection (OWD) is a function which will reduce the thermostat setpoint on detection of an open window. This happens when the temperature sensor registers a rapid temperature drop.

When OWD is active, the setpoint is reduced to 5°C in order not to waste energy. OWD will automatically be cancelled if OWD has been active for more than 1 hour, or if the temperature increases by 3°C. OWD can also be cancelled manually by increasing/decreasing the setpoint with the Left and Right buttons.

By default, OWD is not enabled. The feature may be enabled by selecting "OWD" from the menu. Choose between options "OFF" and "ON". It can also be enabled by setting Parameter 25 "Open window detection" to 1.

23. ERROR CODES

- Err Adding fail.
See Chapter "Add/Remove".
- Err1 Internal error.
Most probably a faulty unit. Contact support.
- Err2 WiFi error.
Most probably a faulty unit. Contact support.
- Err3 Internal error.
Most probably a faulty unit. Contact support.
- Err4 Floor sensor error.
You have chosen F, AF or A2F sensor mode without having a floor sensor connected, or the sensor may be damaged.
- Err5 External sensor error.
You have chosen A2 or A2F sensor mode without having an external sensor connected, or the sensor may be damaged.

- Err6 Overheating.
Contact your electrician.

- Err7 Overload.
Contact your electrician.

24. SAFETY FEATURES

The device has safety features to ensure safe operation and warn the user of any faults/unexpected behavior. The device has an Overheat and Overload function. If the thermostat registers an Overheat or Overload incident, the thermostat will switch off and an error will appear in the display.

24.1 Overheating

The device features internal temperature sensors that detect overheating. It warns the user and turns off the relay to prevent any damage.

When overheating is detected, the device will:

- Turn off the relay.
- Display Err6 in the display.
- Send a notification to the "MyHeatit" App.

24.2 Overload

The device features a 16A overload protection. The overload is triggered if there is a current draw of more than 16A.

When overload is detected, the device will:

- Turn off the relay.
- Display Err7 in the display.
- Send a notification to the "MyHeatit" App.

24.3 Sensor failure

The device has the ability to detect when there is no sensor connected or the sensor is broken or otherwise defective, causing an open circuit.

When the device detects the sensor error, the device will:

- Turn off the relay.
- Display an error in the display, changes based on which sensor is not connected/faulty.

To clear the "Sensor not connected" error the device has to be disconnected from the mains, and the wiring and sensor(s) need to be checked. When the fault is resolved the mains can be reconnected and the device will function normally again.

25. ASSOCIATIONS (PENDING)

Devices interact with other devices. The relationship between these devices is called an association. In order to control a subordinate device, the controlling device needs to maintain a list of devices that will receive controlling commands. These lists are called "Associations". They are always related to the specific event triggered (e.g., relay state change). In case the event is triggered, all the devices stored in the respective association will receive a command to perform an action.

25.1 Setting and Removing Associations

On the "Devices" page, select the device intended for controlling another device. Click "Associations", choose the desired function (e.g., relay state, setpoint). Then select the devices to be controlled by the controlling device and hit "Save".

26. CONFIGURATION PARAMETERS

Heatit products are supposed to work out of the box after inclusion. Some device configuration may, however, alter the functionality to better serve user needs or unlock further enhanced features.

PARA. NO#	NAME	SHORT DESCRIPTION / COMMENT	MIN	MAX	DEFAULT	DESCRIPTION OF VALUE
1	Disable buttons	Disable buttons, must be enabled through the parameter, or turned back on locally by holding the center and right button for 30 seconds until the display shows "UNLK".	0	1	0	Enabled, buttons on the front of the device work. (Default) Disabled, buttons on the front of the device are disabled.
2	Sensor mode (OPER)	Choose which sensors the thermostat should use for regulation.	0	4	1	F, Floor sensor A, Internal sensor (Default) AF, Internal sensor with floor sensor limitations A2, External sensor A2F, External sensor with floor sensor limitations PWER, Power regulator mode
3	Sensor value (SEN)	Select the resistance value of the connected NTC.	0	7	0	10KΩ (Default) 12KΩ 15KΩ 22KΩ 33KΩ 47KΩ 6.8KΩ 100KΩ
4	Internal sensor min temp limit	Decides the lowest temperature allowed by the thermostat when using sensor mode A.	50	400	50	5°C to 40°C (Default is 5°C)
5	Floor sensor min temp limit	Decides the lowest temperature allowed by the thermostat when using sensor mode AF, F, A2F.	50	400	50	5°C to 40°C (Default is 5°C)
6	External sensor min temp limit	Decides the lowest temperature allowed by the thermostat when using sensor mode A2, A2F.	50	400	50	5°C to 40°C (Default is 5°C)
7	Internal sensor max temp limit	Decide the highest temperature allowed by the thermostat when using sensor mode A.	50	400	400	5°C to 40°C (Default is 40°C)
8	Floor sensor max temp limit	Decide the highest temperature allowed by the thermostat when using sensor mode AF, F, A2F.	50	400	400	5°C to 40°C (Default is 40°C)
9	External sensor max temp limit	Decide the highest temperature allowed by the thermostat when using sensor mode A2, A2F.	50	400	400	5°C to 40°C (Default is 40°C)
10	Internal sensor calibration (CAR)	Manually calibrate sensor A ±6°C.	-60	60	0	-6.0°C to 6.0°C Calibrates the sensor by ±6°C. (Default is 0°C)
11	Floor sensor calibration (CAF)	Manually calibrate sensor F ±6°C.	-60	60	0	-6.0°C to 6.0°C Calibrates the sensor by ±6°C. (Default is 0°C)
12	External sensor calibration (CAE)	Manually calibrate sensor A2 ±6°C.	-60	60	0	-6.0°C to 6.0°C. Calibrates the sensor by ±6°C. (Default is 0°C)
13	Regulation mode (REG)	Choose between regulation modes PWM and Hysteresis.	0	1	0	Hysteresis PWM regulation
14	Temperature control hysteresis (HYST)	Choose the hysteresis used when regulation mode is set to HYST.	3	30	5	0.3°C to 3.0°C. Default is 5 (0.5°C)
15	Temperature display	Select what is shown on the display during Standby state.	0	1	0	Display setpoint temperature. (Default) Display measured temperature.
16	Active display brightness (BR1)	Configure the brightness of the display during active state.	1	10	10	10 to 100% (Default 100%)
17	Standby display brightness (BR2)	Configure the brightness of the display during standby state.	1	10	5	10 to 100% (Default 50%)
18	Action after error	Decide how the device should react when the overload / overheating features has turned OFF relay.	0	65535	0	0, device will turn off and show an error in the display. (Default) 10 to 65535 seconds, device will attempt to turn on again after an error based on the delay specified.
19	Heating setpoint	Set setpoint for Heating mode.	50	400	210	5°C to 40°C. 21°C (Default)
20	Cooling setpoint	Set setpoint for Cooling mode.	50	400	180	5°C to 40°C. 18°C (Default)

PARA. NO#	NAME	SHORT DESCRIPTION / COMMENT	MIN	MAX	DEFAULT	DESCRIPTION OF VALUE
21	ECO setpoint	Set setpoint for ECO mode.	50	400	180	5°C to 40°C. 18°C (Default)
22	Power regulator active time	Set the % of time the relay should be active when using PWER mode. (30-minute duty cycle).	1	10	2	1 - 10 10 to 100%. 20% (Default)
23	Thermostat state update interval	Set the time interval of how often the associated devices updates.	0	65535	45200	Sends only when changed. 30 to 65535 seconds. 43200 seconds + when changed. (Default)
24	Operating Mode (MODE)	Set the thermostat mode.	0	3	1	OFF Thermostat will not operate Heating mode (Default) Cooling mode ECO mode
25	Open window detection	Choose to enable or disable the Open windows detection.	0	1	0	Open window detection disabled. (Default) Open windows detection enabled.
26	Size of load	Allows the user to decide the power consumption of the connected load in 100W increments.	1	99	0	Uses power metering values. (Default) 1-99 = 100-9900 Watt Allows the user to set the size of the load, used when connected to a contactor.

27. INDICATOR

The device has an indicator that will flash the display. This can be used while including to identify a device, and allow for it to be linked to the correct room within the "MyHeatit" App.

28. THERMOSTAT DIMENSIONS

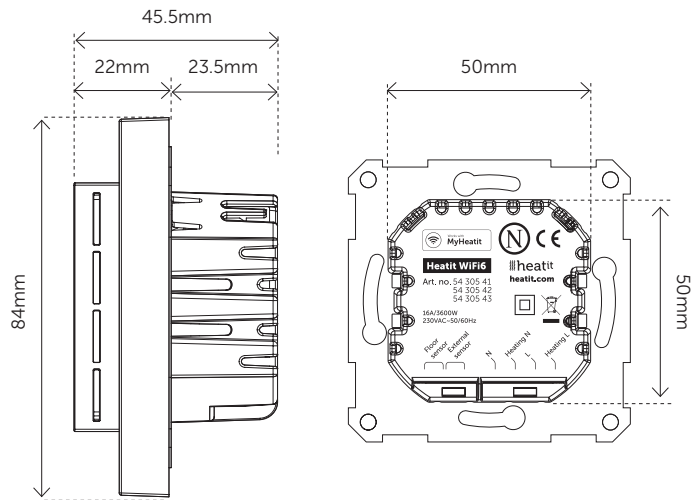

29. THERMOSTAT CONTROLS

ICON	DESCRIPTION
—	Previous. Decrease set temperature.
≡	Menu confirm. Menu enable.
+	Next. Increase set temperature.

30.CHART - DISPLAY MENU STRUCTURE

Hold the middle button for 5 seconds to enter menu.

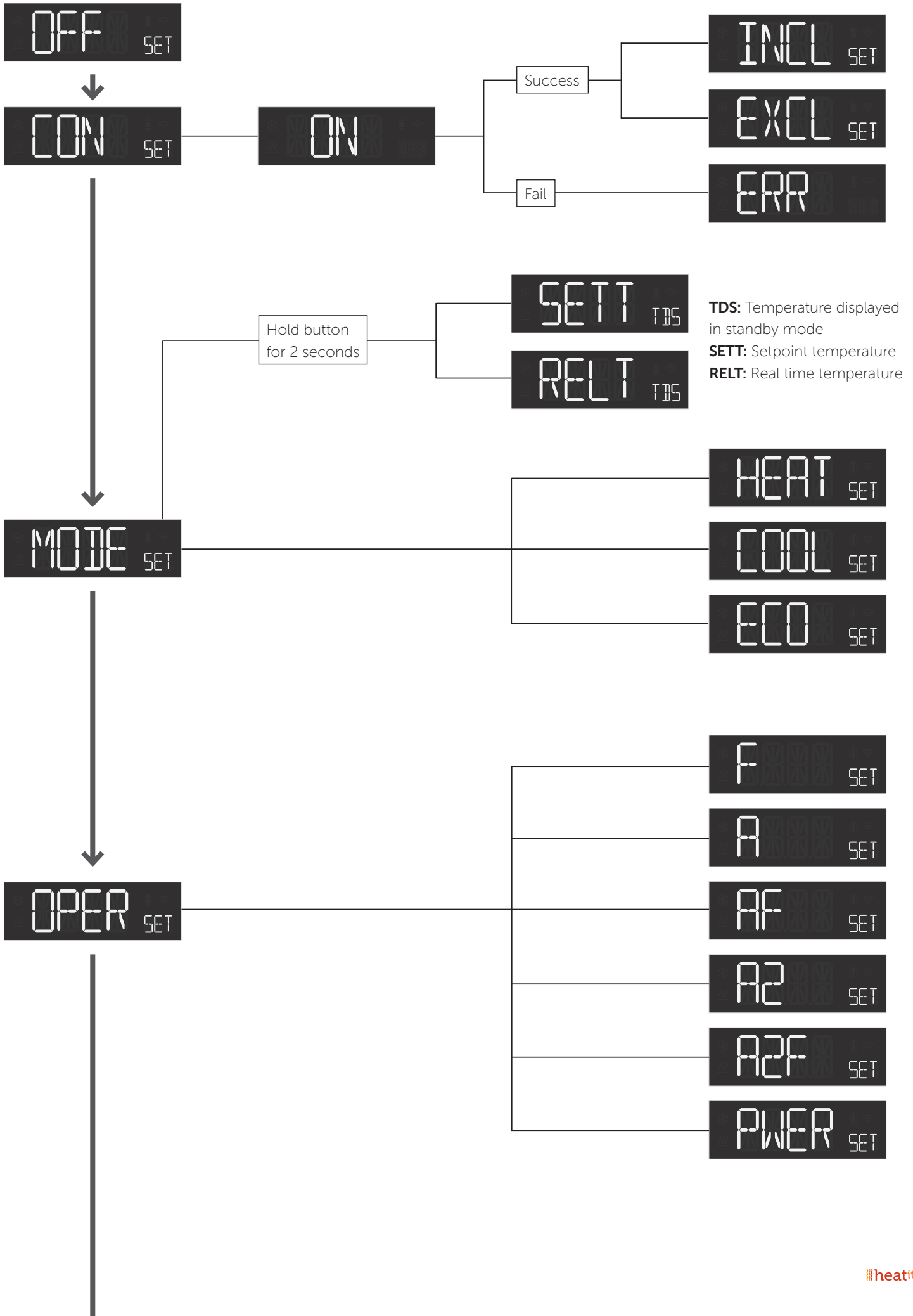

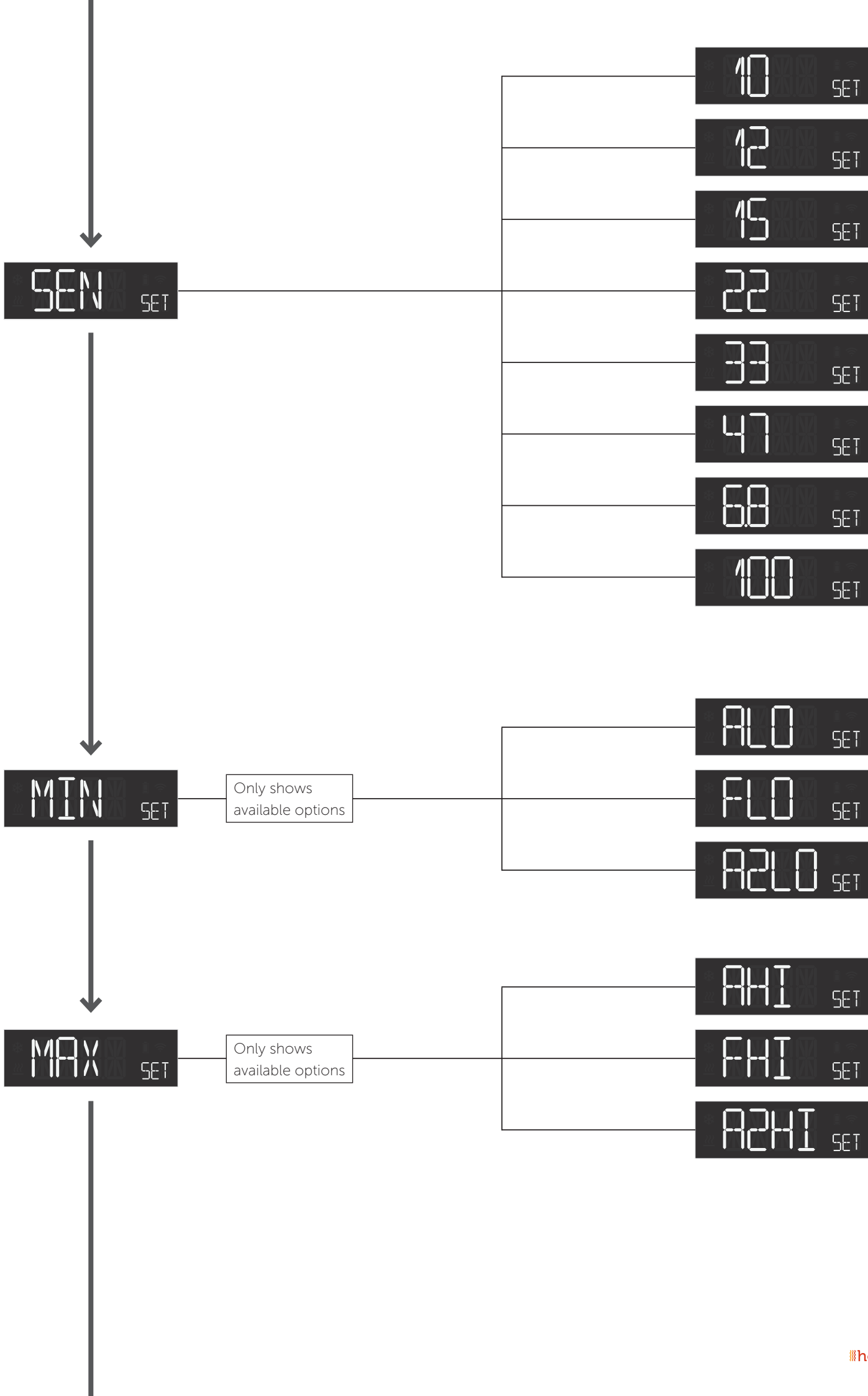

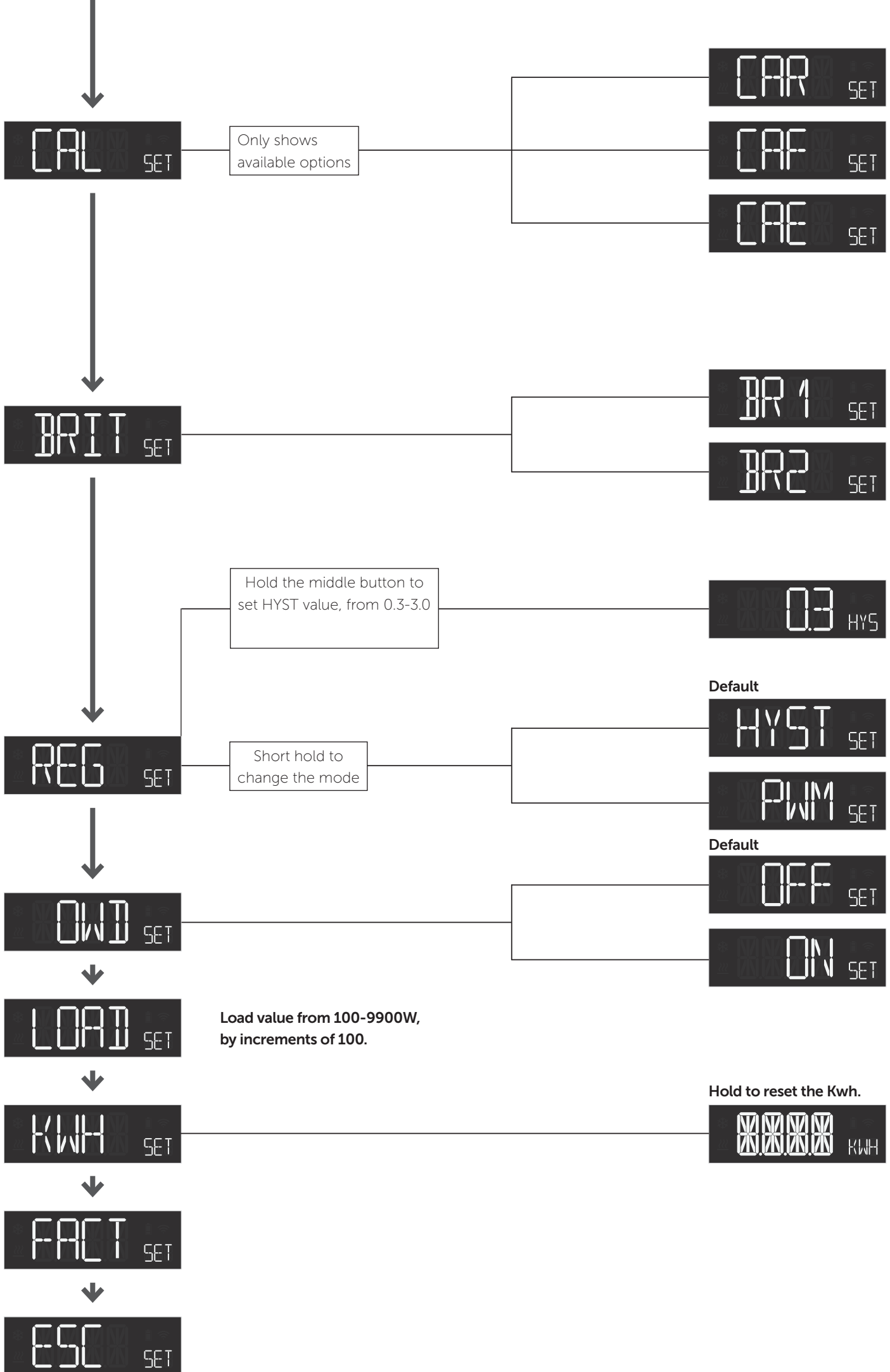

30.1 Error messages in display

	Failed to include
	Internal error: MCU and ESP chip communication failed
	Wi-Fi error
	Internal sensor error
	Floor sensor error
	External sensor error
	Overheat
	Overload

30.2 General display messages

	Childlock activated
	Childlock disabled
	Backlight on when device in standby
	Backlight off when device in standby
	Open window detected
	Settings stored

DISPOSAL GUIDELINES / LIABILITY INFORMATION

Do not dispose of electrical appliances as unsorted municipal waste, use separate collection facilities. Contact your local government for information regarding the collection systems available. If electrical appliances are disposed of in landfills or dumps, hazardous substances can leak into the groundwater and get into the food chain, damaging health and well-being.



We develop and design our products according in accordance with our strict quality requirements (ISO 9001) and environmental requirements (ISO 14001). All electrical installations must be carried out by an authorized electrical installer. The product must be installed in accordance with our installers manual and national building codes. Any wrongful installation, misuse, damage of the product, is not covered under warranty. Updated documentation is available at www.heatit.com and/or documents.heatit.com. Heatit Controls AB can not be held liable for any type of errors or omissions in our product information. Product specifications may change without further notice.

PRODUCT INFO Heatit WiFi6

FEATURES

- Wi-Fi/BLE thermostat
- Internal room sensor
- External room sensor (wired by cable)
- Floor sensor
- Power regulator
- Temperature limiter
- 3 modes; Heat - Cool and Eco
- Hysteresis/PWM
- Temperature calibration
- Open window detection
- ZeroX detection
- Relay status icon
- Adjustable display brightness
- Single pole switch
- Lock mode/child lock
- Google Home, Amazone Alexa and open API (pending)
- Weekly schedule in app
- Profiles; Home - Away - Night - Holiday
- Active power metering
- Firmware update (OTA)

TECHNICAL DATA

Protocol	Wi-Fi 2.4GHz/BLE
Rated voltage	230VAC 50Hz
Max load	3600W 16A (resistive load) Contactor recommended for loads above 13A
Max current	16A
Power consumption	<2W
Power regulator	Time cycle 30 min.
Ambient temperature	5°C to 40°C
Temperature range	5°C to 40°C
Storage temperature	-30°C to 70°C
Hysteresis	0.3°C to 3.0°C (default 0.5°C)
Humidity	10% to 85% RH
Compatible with NTC-sensor with values	6.8, 10, 12, 15, 22, 33, 47 or 100kΩ @ 25°C
Screw terminals	Max. 2.5mm ² 2Nm
IP Code	IP21
Size (LxWxH)	84 x 84 x 45.5mm
Approvals	CE, Nemko

The distance between user and products should be no less than 20cm.

MAINTENANCE

The device is maintenance-free. Indoor use only.



Heatit Controls AB • Låkarvägen 4, 454 31 BRASTAD, SWEDEN

Phone: +47 61 18 77 77 • post@heatit.com • heatit.com