

Incara™ Pop Up

Cat. No(s) : 6 548 00 to 03 - 6 548 08 to 11 - 6 548 16/17/20/22/23/27/28 - 6 548 30 to 35/39

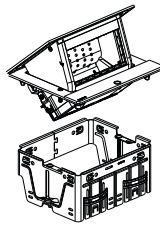

6 548 00/01/02/03

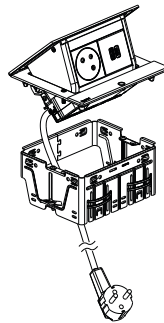

6 548 16/17/27

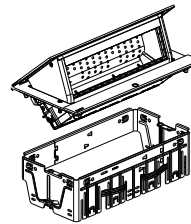

6 548 08/09/10/11

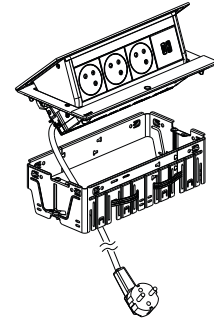

6 548 20

1. USE

Incara™ Pop up is a modern and aesthetic solution to bring power and data to the workstation and meeting room. Available with 4 or 8 modules, Incara™ Pop up is available pre-equipped with power functions (power socket and USB charger) or to be equipped with power, data or A/V functions from the Mosaic range.

2. RANGE

2.1 Pop up equipped

2.1.1 French & Schuko Standards

Incara™ Pop Up equipped with 2 m cord & 2P+E plug			Standards			
			French		Schuko	
			Brushed aluminium	White	Brushed aluminium	White
4 modules	1x 2P+E	1 USB A+C 15 W	6 548 16	6 548 17	6 548 22	6 548 23
		1 USB C 30 W PD	6 548 27	-	6 548 28	-
8 modules	3x 2P+E	1 USB A+C 15 W	6 548 20	-	-	-

2.1.2 British Standard

Incara™ Pop Up equipped			British Standard - Brushed aluminium Finishes - equipped with		
			0,5 m cord	2 m cord	
			GST18i3 connector	BS1363 plug	Intersoc R connector
4 modules	1x 2P+E	1 USB A+C 15 W	6 548 31	6 548 30	6 548 32
		1 USB C 30 W PD	-	6 548 39	-
	2x 2P+E	-	6 548 34	6 548 33	6 548 35

2.2. Pop up to be equipped

Incara™ Pop Up to be equipped		Finishes			
		Brushed aluminium	White	Black	Aluminium
4 modules		6 548 00	6 548 01	6 548 02	6 548 03
8 modules		6 548 08	6 548 09	6 548 10	6 548 11

3. DIMENSIONS

■ **3.1 Incara™ Pop Up 4 modules**

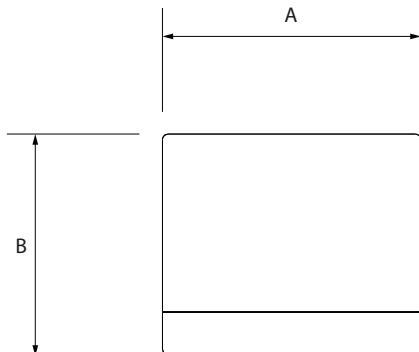

Cat. Nos	A	B
6 548 00/01/02/03/16/17/22/23/27/28/30/31/32/33/34/35/39	146	125

■ **3.2 Incara™ Pop Up 8 modules**

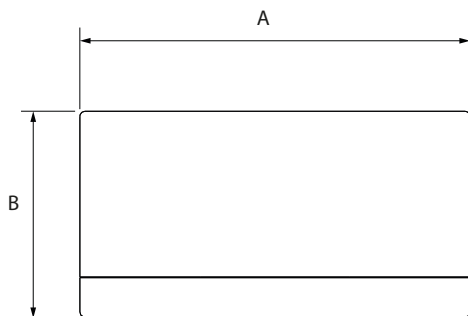

Cat. Nos	A	B
6 548 08/09/10/11/20	236	125

3. DIMENSIONS (cont.)

■ **3.3 Incara™ Pop Up closed position**

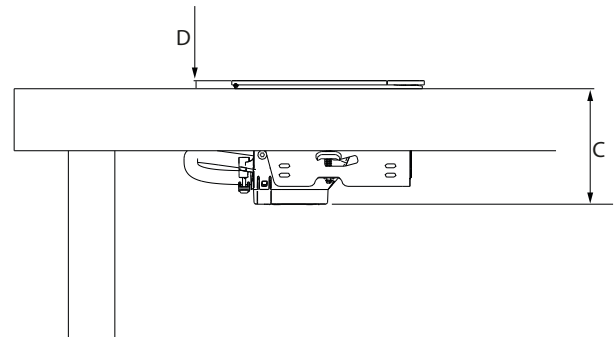

Cat. Nos	C	D
6 548 00/01/02/03/08/09/10/11/16/17/20/22/23/27/28/30/31/32/33/34/35/39	75	5,2

■ **3.4 Incara™ Pop Up opened position**

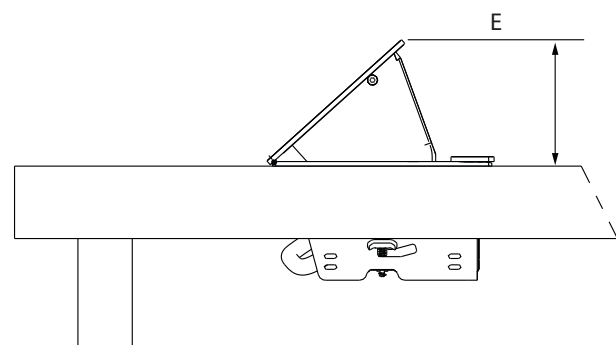

Cat. Nos	E
6 548 00/01/02/03/08/09/10/11/16/17/20/22/23/27/28/30/31/32/33/34/35/39	70

4. INSTALLATION

Must not be fitted on the floor.

■ **4.1 Into the desk**

4.1.1 Drilling dimensions and max cut-out radius in corners

4.1.1.1 Sharp edges cut-out

	A
6 548 16/17/22/23/27/28/30/31/ 6 548 32/33/34/35/39	129 mm ± 1
6 548 20	219 mm ± 1

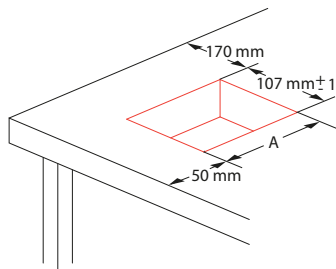

4.1.1.2 CNC machining cut-out

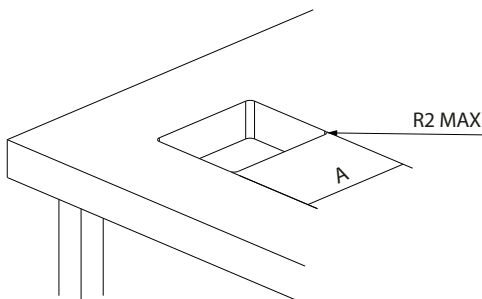
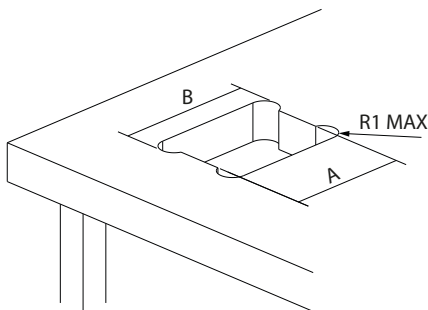

Pop Up	A	B	R1 MAX	R2 MAX
4 modules	129 mm ± 1	135 maxi	12	6
8 modules	219 mm ± 1	225 maxi		

4. iNSTALLATION (cont.)

4.1.2 Dimensions under desk

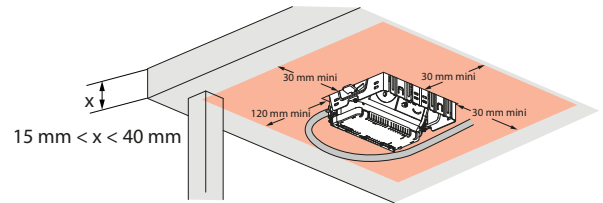

4.1.3 Insertion

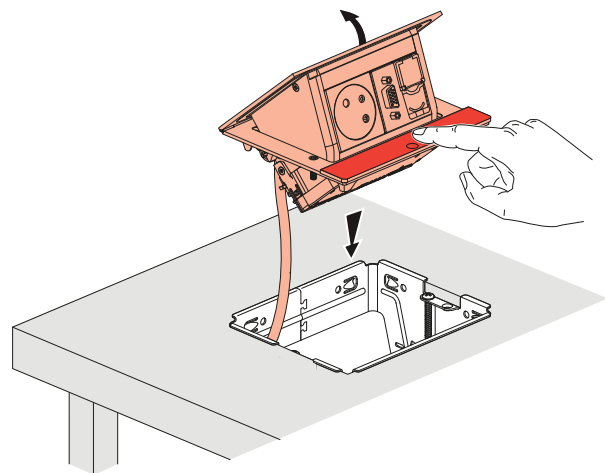

4.1.4 Use

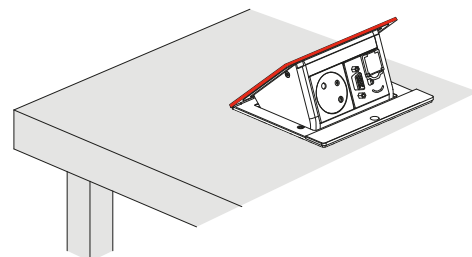
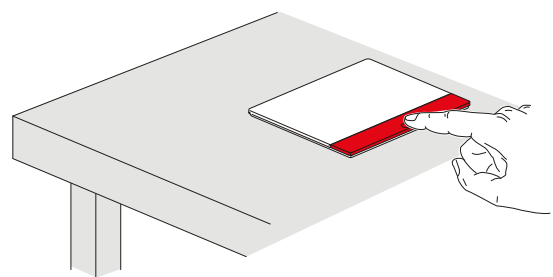

5. TECHNICAL CHARACTERISTICS

■ 5.1 Mechanical characteristics

Resistance to Impact: IK 07 (part on desk)
IK 04 (part under desk)
Degree of protection provided by housings: IP 20

■ 5.2 Material characteristics

Wiring devices frame: Aluminium, Zamak, ABS
Insulation box: PC-ABS
Mounting frame: Steel

■ 5.3 Electrical characteristics

5.3.1 2 P+T sockets characteristics

- Supply voltage: 250V~
- Frequency: 50/60 Hz
- Rated current:
 - . for French & Schuko standards = 16A
 - . for British standard : individually fused = 5A

5.3.2 USB charger characteristics

refer to technical data sheet of USB charger for cat. nos 0 775 92
and 0 775 85L

5.3.3 RJ45 characteristics

refer to technical data sheet of cat. no 0 765 62 for example

5.3.4 Cords characteristics

H05VV-F 3G 1.5mm²

■ 5.4 Audio/Video characteristics (preterminated HDMI)

refer to technical data of cat. no 0 787 78 for example

■ 5.5 Climate characteristics

Operating temperature: from -5°C to +35°C

6. CLEANING

Storage temperature: from -10°C to +70°C

Superficial cleaning with a soft cloth. Do not use abrasive products or detergents.

Caution : Always test before using other special cleaning products

7. STANDARDS AND APPROVALS

Compliant to:

Standards			
French	Schuko	British	
		socket	complete product
NF C61-314 and IEC 60884-1	IEC 60884-1	BS 1363-2	BS 5733

USB charger compliant to IEC 62368-1

Products should be installed by competent persons to the current version of the local wiring regulations.

Please consult Legrand locally for further details.