

## Mosaic™ Cover plates

Cat. No(s): 0 788 01L/02L/03L/04L/06L/08L/10L/11L/14L/15L/16L/18L/22L/23L/25L/28L/30L/32L/36L/37L/38L/54L/56L/64L/66L  
0 793 01L/02L/03L/04L/06L/08L/10L/11L/14L/15L/16L/18L/22L/23L/25L/28L/30L/32L/36L/37L/38L/54L/64L  
0 790 42L/44L/46L/54L/56L/58L/62L/76L/77L - 0 994 84 - 0 788 50L/52L/62L/53L/63L - 0 791 57L

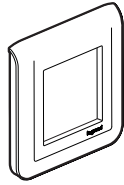

0 788 02L  
0 793 02L  
0 790 42L

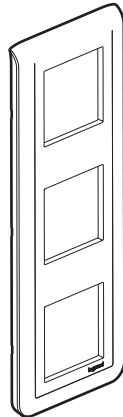

0 788 23L  
0 793 23L

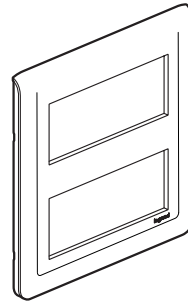

0 788 30L  
0 793 30L

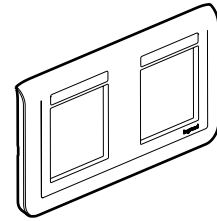

0 788 52L  
Porte-étiquette

### 1. USE

Plates for covering mechanisms with 1 to 2 x 10 modules.  
And cover plates with integrated label holder for 2 to 3 x 2 module mechanisms.

### 2. RANGE

	White	Alu	Matte Black
1 module narrow	0 788 01L	0 793 01L	-
2 modules	0 788 02L	0 793 02L	0 790 42L
3 modules	0 788 03L	0 793 03L	-
1-gang / 1 module	0 788 11L	0 793 11L	-
4 modules - Horizontal	0 788 14L	0 793 14L	0 790 54L 0 994 84
5 modules - Horizontal	0 788 15L	0 793 15L	-
5 modules - Vertical	0 788 25L	0 793 25L	-
6 modules - Horizontal	0 788 16L	0 793 16L	0 790 56L
8 modules - Horizontal	0 788 18L	0 793 18L	0 790 58L
10 modules - Horizontal	0 788 10L	0 793 10L	-
2 x 2 modules - Horizontal	0 788 04L	0 793 04L	0 790 44L
2 x 2 modules - Vertical	0 788 22L	0 793 22L	0 790 62L
3 x 2 modules - Horizontal	0 788 06L	0 793 06L	0 790 46L
3 x 2 modules - Vertical	0 788 23L	0 793 23L	-
4 x 2 modules - Horizontal	0 788 08L	0 793 08L	-
2 x 5 modules	0 788 30L	0 793 30L	-
2 x 6 modules	0 788 36L	0 793 36L	0 790 76L
2 x 8 modules	0 788 37L	0 793 37L	0 790 77L
2 x 10 modules	0 788 28L	0 793 28L	-
2 x 3 x 2 modules	0 788 32L	0 793 32L	-
2 x 2 x 2 modules	0 788 38L	0 793 38L	-
<b>Plates 57 mm center distance</b>			
2 x 2 modules - Vertical	0 788 54L	0 793 54L	-
2 x 2 modules - Horizontal	0 788 64L	0 793 64L	-
3 x 2 modules - Vertical	0 788 56L	-	-
3 x 2 modules - Horizontal	0 788 66L	-	-

### 3. RANGE (continued)

Plates with integrated label holder - white	
2 modules	0 788 50 L
2 x 2 modules horizontal	0 788 52 L
2 x 2 modules vertical	0 788 62L
3 x 2 modules horizontal	0 788 53L
3 x 2 modules vertical	0 788 63L

### 3. DIMENSIONS (mm)

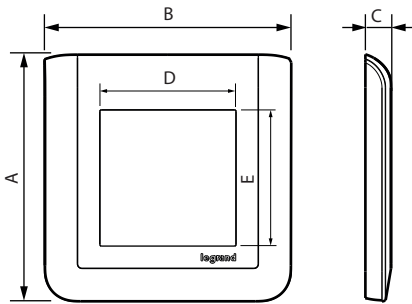

References	A	B	C	D	E
0 788 01L - 0 793 01L	82	40	8.5	23	45.5
0 788 02L - 0 793 02L - 0 790 42L 0 788 50L	82	82	8.5	45.5	45.5
0 788 03L - 0 793 03L	82	123	8.5	68	45.5
0 788 10L - 0 793 10L	82	295	8.5	226.5	45.5
0 788 11L	82	82	8.5	23	45.5
0 788 14L - 0 793 14L - 0 790 54L 0 994 84	82	153	8.5	91	45.5
0 788 15L - 0 793 15L	82	153	8.5	113.5	45.5
0 788 16L - 0 793 16L - 0 790 56L	82	224	8.5	136	45.5
0 788 18L - 0 793 18L - 0 790 58L	82	224	8.5	181	45.5
0 788 04L - 0 793 04L - 0 790 44L 0 788 52L	82	153	8.5	45.5	45.5
0 788 06L - 0 793 06L - 0 790 46L 0 788 53L	82	224	8.5	45.5	45.5
0 788 08L - 0 793 08L	82	295	8.5	45.5	45.5
0 788 22L - 0 790 22L - 0 790 62L 0 788 62L	153	82	8.5	45.5	45.5
0 788 23L - 0 790 23L - 0 788 63L	224	82	8.5	45.5	45.5
0 788 25L - 0 793 25L	153	82	8.5	45.5	113.5
0 788 28L - 0 793 28L	166	318	8.5	226.5	45.5
0 788 30L - 0 790 30L	166	166	9	113.5	45.5
0 788 36L - 0 793 36L - 0 790 76L	166	237	9	136.5	45.5
0 788 37L - 0 793 37L - 0 790 77L	166	237	9	182	45.5
0 788 32L - 0 793 32L	166	237	9	45.5	45.5
0 788 38L - 0 793 38L	166	166	9	45.5	45.5
0 788 54L - 0 793 54L	139	82	8.5	45.5	45.5
0 788 56L	196	82	8.5	45.5	45.5
0 788 64L - 0 793 64L	82	139	8.5	45.5	45.5
0 788 66L	82	196	8.5	45.5	45.5

### 4. TECHNICAL CHARACTERISTICS

#### ■ 4.1 Mechanical characteristics

Impact test: IK 04

#### ■ 4.2 Material characteristics

Halogen-free

UV-resistant

Material of plates: ABS White (RAL 9003) polyglass appearance  
ABS painted Aluminium varnished glittery  
ABS Painted Matt Black satin finish RAL 9017

Material of subplates: PC

Self-extinguishing: 650° C/30 s

#### ■ 4.3 Climate characteristics

Storage temperature: -10°C to +70°C

Usage temperature: -5°C to +35°C

### 5. CLEANING

Surface cleaning with a cloth.

Do not use: acetone, tar remover, trichloroethylene.

**Caution:** A preliminary test should be carried out if other specific cleaning products are to be used.

### 6. SPECIAL USE

Mosaic plates must not be painted.

### 7. ACCESSORIES

For 4, 6 and 10-module plates, use blanking plates:

Plates	Blanking plates
4 modules	0 791 04
6 modules	0 791 06
10 modules	0 791 10

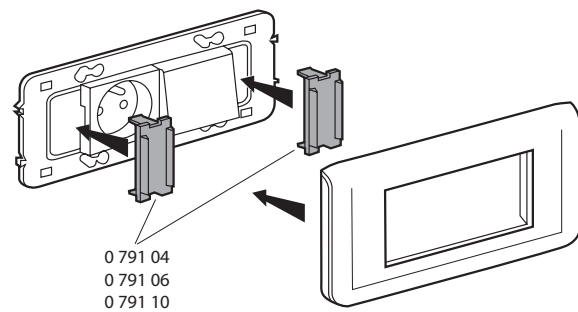

For plates with integrated label holder, accessory ref. 0 791 57L:

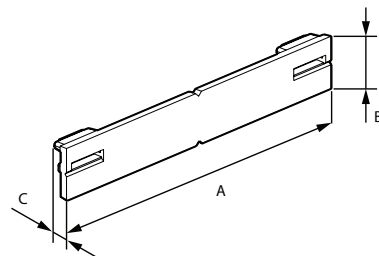

A	B	C
45,3	7	3