

HEATIT PRO

Installers manual



 PRODUCT DOCUMENTS 	
Firmware version FW 1.0	Document version 2024-A
Article no. 54 305 81 54 305 82 54 305 83	Document date 01.07.2024
Org. doc. date 01.07.2024	



TABLE OF CONTENTS

- | | |
|--|--|
| 1. Introduction | 16. Size of load |
| 2. Quick start | 17. Choice of sensor |
| 3. Installation disclaimer | 18. Selecting sensor value |
| 4. Connections | 19. Calibration |
| 5. Installation | 20. Brightness |
| 6. Factory reset | 21. Display on/off |
| 7. Startup | 22. Display icons |
| 8. Principles of regulation | 23. Child lock |
| 9. Waterbased heating/
electrical heating | 24. Open window detection |
| 10. Local settings menu | 25. Anti-freeze function |
| 11. Display menu structure | 26. Error codes |
| 12. Weekly schedule | 27. Safety features |
| 13. Standby and main screen | 28. Thermostat setpoint |
| 14. Weekly schedule and
adaptive function | 29. Thermostat mode |
| 15. Active power metering
values in menu | 30. Thermostat dimensions |
| | 31. Thermostat controls |
| | 32. Chart - display menu
Product info |

1. INTRODUCTION

Heatit Pro is an electronic thermostat designed for electrical heating, waterbased heating and cooling systems. The thermostat has a user-friendly interface that can be controlled from the buttons on the front of the thermostat.

Heatit Pro has 2 modes; Heat and Cool.

The thermostat fits in standard European junction boxes and may be used with most System 55 frames. It has a sturdy metal frame for secure fastening on the junction box. The thermostat has one built-in room temperature sensor. Two additional external temperature sensors may also be connected.

Heatit Pro has the option of a weekly program and open window detection.

The product has implemented ZeroX technology. This technology makes sure the relay switches at 0V when turning on and off. With this technology the thermostat will have a much longer lifetime.

Heatit Pro has active power metering, which allows the user to see the real time power consumption.

The thermostat can withstand a load of max 16A/3600W at 230VAC. We recommend a contactor for loads above 13A.

2. QUICK START

1. Switch off the mains voltage (disable the fuse).
2. Open the junction box.
3. Connect the wires according to the description in Chapter "Connections". Optional: Connect external wired sensors.
4. After verifying the connections, switch on the mains voltage.

3. INSTALLATION DISCLAIMER

Installation must be done by a qualified electrician in accordance with national building codes. Before installation, disconnect the power to the device from the mains. During installation of the device, power to the device must be disconnected AT ALL TIMES!

4. CONNECTIONS

Max tightening torque for terminal screws: 2Nm.

If the cable used has multiple strands, using an end sleeve is advised. The product allows for wiring of cables with a cross section of up to 1x2.5mm².

The screw terminals are located at the back of the device, and are accessible at all times.

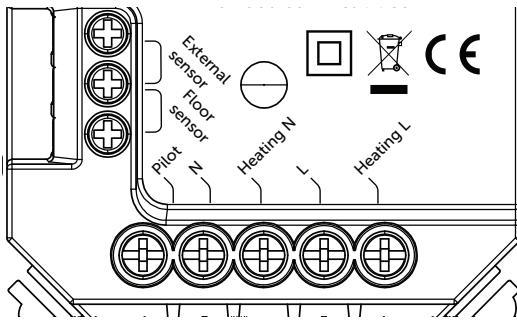

Floor sensor	NTC type 6.8, 10, 12, 15, 22, 33, 47 or 100kΩ. Default 10kΩ.
External sensor	NTC type 6.8, 10, 12, 15, 22, 33, 47 or 100kΩ. Default 10kΩ.
Pilot	Cooling/heating switchover in waterbased mode.
N	Power connection (Neutral) 230VAC.
Heating N	Heating cable N connection.
L	Power connection (Live) 230VAC.
Heating L	Heating cable L connection.

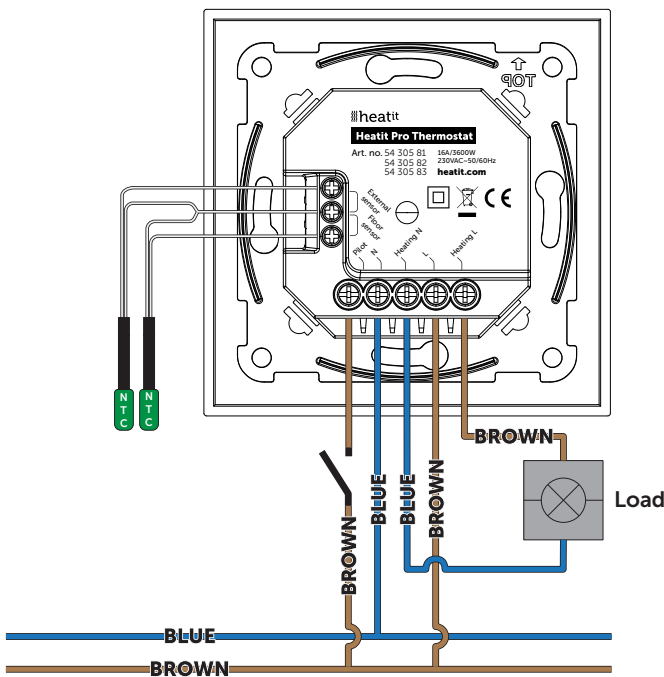

5. INSTALLATION

Position the thermostat and mount it into the junction box using 2 screws. Position the thermostat front over the part mounted in the junction box, then carefully press the front until it clicks into place. In order to get power metering values, the load needs to be connected to both heating L + N.

Never change the front from one thermostat to another.

6. FACTORY RESET

Enter the menu by holding the center button for about 5 seconds, navigate in the menu with the "+" button til you see "ADVA". Press the Center button once, then, navigate til you see "FACT". Press the Center button until you see "-- --" blinking in the display, then hold for about 5 seconds to perform a reset. You may also initiate a reset by holding the Left and Right buttons for 60 seconds. When either of these procedures has been performed, the thermostat will perform a complete factory reset. The device will display "RES" for 5 seconds while performing a factory reset. When "RES" is no longer displayed, the thermostat has been reset.

7. STARTUP

After powering up the device for the first time, all parameters will have default settings and the thermostat will start by asking for the date and time.

8. PRINCIPLES OF REGULATION

The thermostat uses temperature readings retrieved from the internal sensor and/or from external wired sensors to regulate the temperature. The thermostat will regulate the temperature using hysteresis or PWM, based on the setpoint temperature.

8.1 Hysteresis

Hysteresis will turn on and off the load based on the hysteresis value in comparison to the setpoint. You can make changes to the thermostat hysteresis. It may be changed by entering the local settings menu and pressing the Center button when "HYST" is displayed. Here you can choose values between 0.5 and 10. The default setting is 0.5°C. When using waterbased heating we recommend a hysteresis of 1.0°C.

8.2 Pulse-width modulation PWM

With PWM regulation enabled, the thermostat will regulate based on duty cycles. The thermostat is turned on and off in percentage intervals of the cycle. The amount of time the relay will be on is based on how far the measured temperature is from the setpoint.

9. WATERBASED HEATING/ELECTRICAL HEATING

The thermostat can be set to be used with either electrical heating, or waterbased heating. Depending on which choice is made, some menu items and operations will be different.

9.1 Automatic valve exercise

Valve exercising is beneficial during longer periods of inactivity to ensure the proper operability of the valves and prevent the valves from getting stuck. If not exercised, corrosion or other buildup may result in the valve becoming inoperable or prevent complete closure.

NB! This function on by default with 5 minutes timer when waterbased heating is active. If you do not control an actuator, it is recommended to turn off this function.

9.2 Waterbased heating/NCNO

While in waterbased heating mode, you can change the NCNO menu option. Using this menu option will change between Normally Open and Normally Closed. Holding center button when NCNO is displayed will allow you to adjust automatic valve exercise timer.

10. LOCAL SETTINGS MENU

To enter the settings menu, hold the Center button for 5 seconds. The display will show "PROF". You are now in the settings menu. You can now scroll up and down using the Left and Right buttons. Some menu items are in the "ADVA" (advanced) submenu. To navigate the submenus, press the Center button once to enter or exit the submenu. Press the Left and Right buttons to find your desired value and hold the Center button for 2 seconds to confirm your selection. "STOR" will appear to indicate settings are stored.

11. DISPLAY MENU STRUCTURE

See flowchart at the end of this manual.

12. WEEKLY SCHEDULE

To enable the weekly schedule, enter the menu, navigate to "PROF" and select "AUTO". The following options are available, each with six different time slots to configure the temperatures.

WEE Mon-Fri and Sat-Sun program.

WDA Mon-Sat and Sun program.

WEN Same program whole week.

DAY Each day individually programmed with 6 settings.

13. STANDBY AND MAIN SCREEN

When the thermostat remains untouched for a while, it will automatically go to the standby screen. By pressing any button once, you will see the thermostats setpoint. By pressing the Left or Right button multiple times, you will change the setpoint.

14. WEEKLY SCHEDULE AND ADAPATIVE FUNCTION

14.1 Weekly schedule

You can customize the thermostat to change its setpoint at different times throughout the week. There are several weekly profiles and preset times available that you can configure.

14.2 Setting a weekly schedule

Enter the menu and press the center button on "PROF", then select "AUTO", and hold the center button to confirm the selection. After selecting "AUTO", there will be a "PROG" option in the menu. Press the center button to enter the programming mode for the weekly schedule. There you can choose your program type, and configure the times and temperatures.

14.3 Adaptive function

The adaptive function learns the time required to heat the room. The thermostat will aim to reach the scheduled temperature at the specified time in your weekly plan.

15. ACTIVE POWER METERING VALUES IN MENU

The device supports active power metering to give insight into the power consumption of the heating. The active power metering information can be seen from the menu. Navigate to "POW" under "ADVA" and press the Center button to scroll through amps, voltage, watts and kWh.

16. SIZE OF LOAD

Hold the center button for 2 seconds while "POW" is displayed to manually set the value of the connected load from 100W to 6500W with 100W increments.

17. CHOICE OF SENSOR

The thermostat has multiple sensors and sensor modes. This lets you configure the thermostat to work correctly in most installations. The sensors and modes may be selected from the local settings menu ("MODE").

Available sensor modes:

F Floor sensor

A Internal room sensor

AF Internal room sensor + Floor sensor

A2 External room sensor

A2F External room sensor + Floor sensor

NOTE: Some types of floor require that a floor sensor is connected in order to limit the floor temperature to a maximum of 27°C (check the manual from the floor manufacturer). When the thermostat is used in (AF or A2F) the floor limiter FHI is automatically set to 27°C. When using any other sensor type (A, F or A2) the minimum and maximum limits are 5°C and 40°C respectively.

18. SELECTING SENSOR VALUE

The thermostat allows the selection of multiple different resistance values of an NTC sensor and can be selected using the local settings menu. The supported sensor values are as follows: 6.8, 10, 12, 15, 22, 33, 47 or 100kΩ.

The factory default value is 10kΩ. When connecting both the floor sensor and the external sensor, make sure to use sensors with the same Ohm value.

19. CALIBRATION

If the temperature sensor readout is not correct, you can make minor changes to the temperature readout. The temperature readings can be calibrated by $\pm 10^{\circ}\text{C}$. The temperature calibration can be performed from the menu using CAR, CAE and CAF. The adjusted value will be displayed indicating what the thermostat uses for regulation.

SENSOR TYPE	IN MENU STRUCTURE
Internal sensor	CAR
External sensor	CAE
Floor sensor	CAF







20. BRIGHTNESS

Using the menu choices "BR1" and "BR2", the brightness of the display in Active and Standby state can be changed respectively.

21. DISPLAY ON/OFF (DON/DOFF)

The thermostat has a display ON/OFF function which decides whether the display should turn completely off when in Standby. To enable/disable this function, hold the Right and Center buttons for 10 seconds. The display will show "DOFF" when the function is activated and "DON" when the function is disabled. When operating any button, the display will light up.

22. DISPLAY ICONS

ICON	DESCRIPTION
	This icon will be displayed while the relay is on and the thermostat is in Heating mode.
	This icon will be displayed while the relay is on and the thermostat is in Cooling mode.
	This icon will be displayed while the thermostat is operating in Manual mode.
	This icon will be displayed while the thermostat is operating in AUTO mode (weekly schedule).
	This icon will be displayed while Open window detection is activated on the thermostat.
	This icon will be displayed while Anti-freeze is activated on the thermostat.

23. CHILD LOCK

The child lock function disables the buttons on the display. It will show "LOCK" when attempting to operate it while the function is enabled. To enable or disable the function, hold the Center and Left buttons for 10 seconds. Enabling the function will show "LOCK" in the display, disabling the function will show "OPEN".

24. OPEN WINDOW DETECTION

Open Window Detection (OWD) is a function which will reduce the thermostat setpoint on detection of an open window. This happens when the temperature sensor registers a rapid temperature drop.

When OWD is active, the setpoint is reduced to 5°C in order not to waste energy. OWD will automatically be cancelled if OWD has been active for more than 1 hour, or if the temperature increases by 3°C. OWD can also be cancelled manually by increasing/decreasing the setpoint with the Left and Right buttons.

By default, OWD is not enabled. The feature may be enabled by selecting "OWD" from the menu. Choose between options "OFF" and "ON".

25. ANTI-FREEZE FUNCTION

Anti-freeze (ANTI) helps to reduce the chance of damage due to very low temperatures.

When anti-freeze is active, you can choose a setpoint between 5°C and 10°C. The thermostat will start heating even when it is in OFF mode.

ERROR CODES

- Err1 Internal error. Most probably a faulty unit. Contact support.
- Err3 Internal error. Most probably a faulty unit. Contact support.
- Err4 Floor sensor error. You have chosen F, AF or A2F sensor mode without having a floor sensor connected, or the sensor may be damaged.
- Err5 External sensor error. You have chosen A2 or A2F sensor mode without having an external sensor connected, or the sensor may be damaged.
- Err6 Overheating. Contact your electrician.
- Err7 Overload. Contact your electrician.

26. SAFETY FEATURES

The device has safety features to ensure safe operation and warn the user of any faults/unexpected behavior. The device has an Overheat and Overload function. If the thermostat registers an Overheat or Overload incident, the thermostat will switch off and an error will appear in the display.

26.1 Overheating

The device features internal temperature sensors that detect overheating. It warns the user and turns off the relay to prevent any damage.

When overheating is detected, the device will:

- Turn off the relay.
- Display Err6 in the display.

26.2 Overload

The device features a 16A overload protection. The overload is triggered if there is a current draw of more than 16A.

When overload is detected, the device will:

- Turn off the relay.
- Display Err7 in the display.

26.3 Sensor failure

The device has the ability to detect when there is no sensor connected or the sensor is broken or otherwise defective, causing an open circuit.

When the device detects the sensor error, the device will:

- Turn off the relay.
- Display an error in the display, changes based on which sensor is not connected/faulty.

To clear the "Sensor not connected" error the device has to be disconnected from the mains, and the wiring and sensor(s) need to be checked. When the fault is resolved the mains can be reconnected and the device will function normally again.

27. THERMOSTAT SETPOINT

The device supports 2 setpoints: Heating and Cooling. Supported setpoints are from 5°C - 40°C with 0.5°C increments.

28. THERMOSTAT MODE

It is possible to change the operating mode of the thermostat in the Mode menu. The accessible operating modes are:

- OFF Thermostat regulation and display are deactivated.
- Heating Mode Thermostat regulation is active.
- Cooling Mode Thermostat regulation is inverted.

29. THERMOSTAT DIMENSIONS

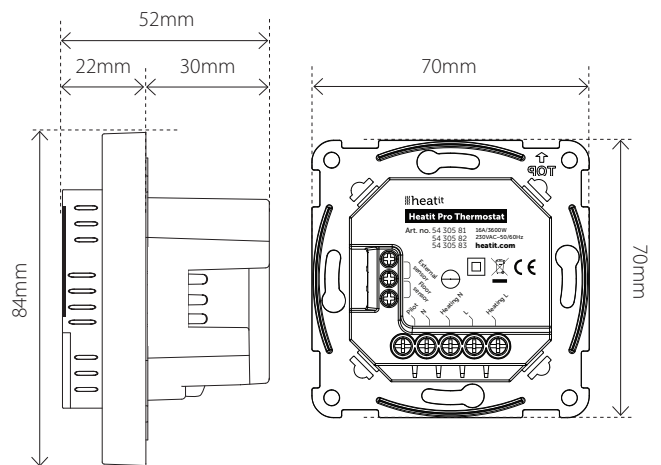

30. THERMOSTAT CONTROLS

ICON	DESCRIPTION
—	Previous. Decrease set temperature.
≡	Menu confirm. Menu enable.
+	Next. Increase set temperature.

31. CHART - DISPLAY MENU STRUCTURE

Hold the middle button for 5 seconds to enter menu.

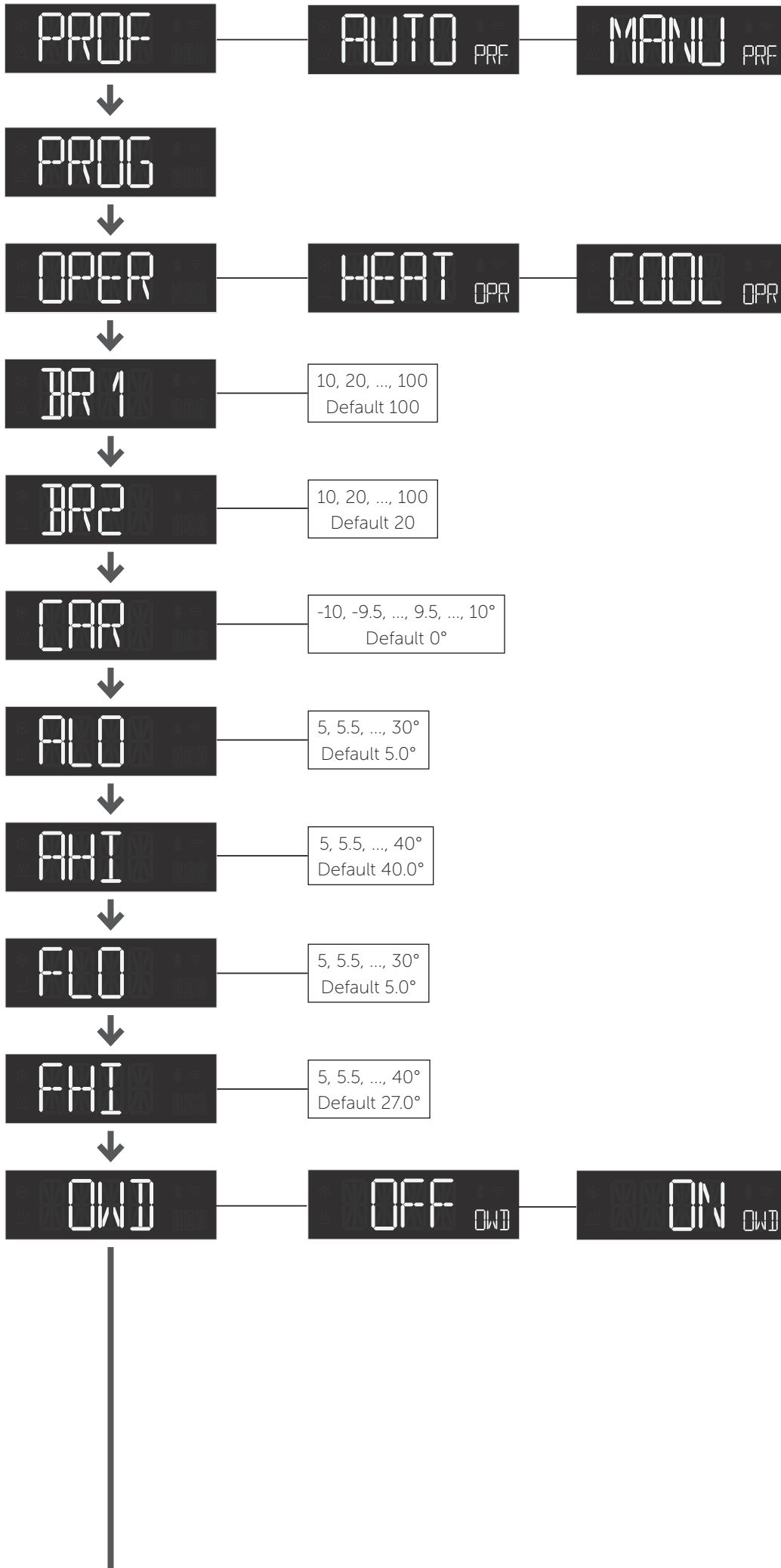

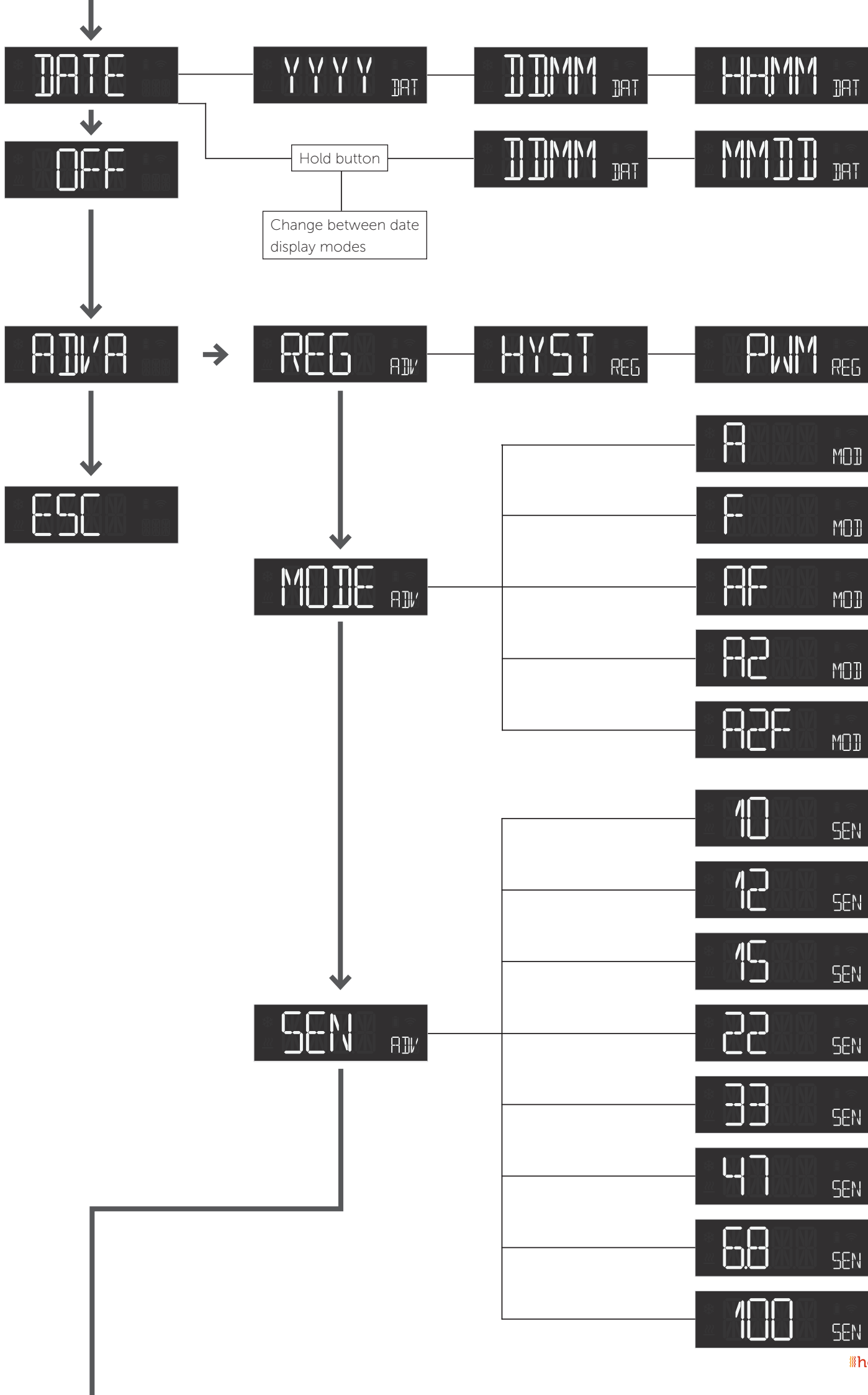

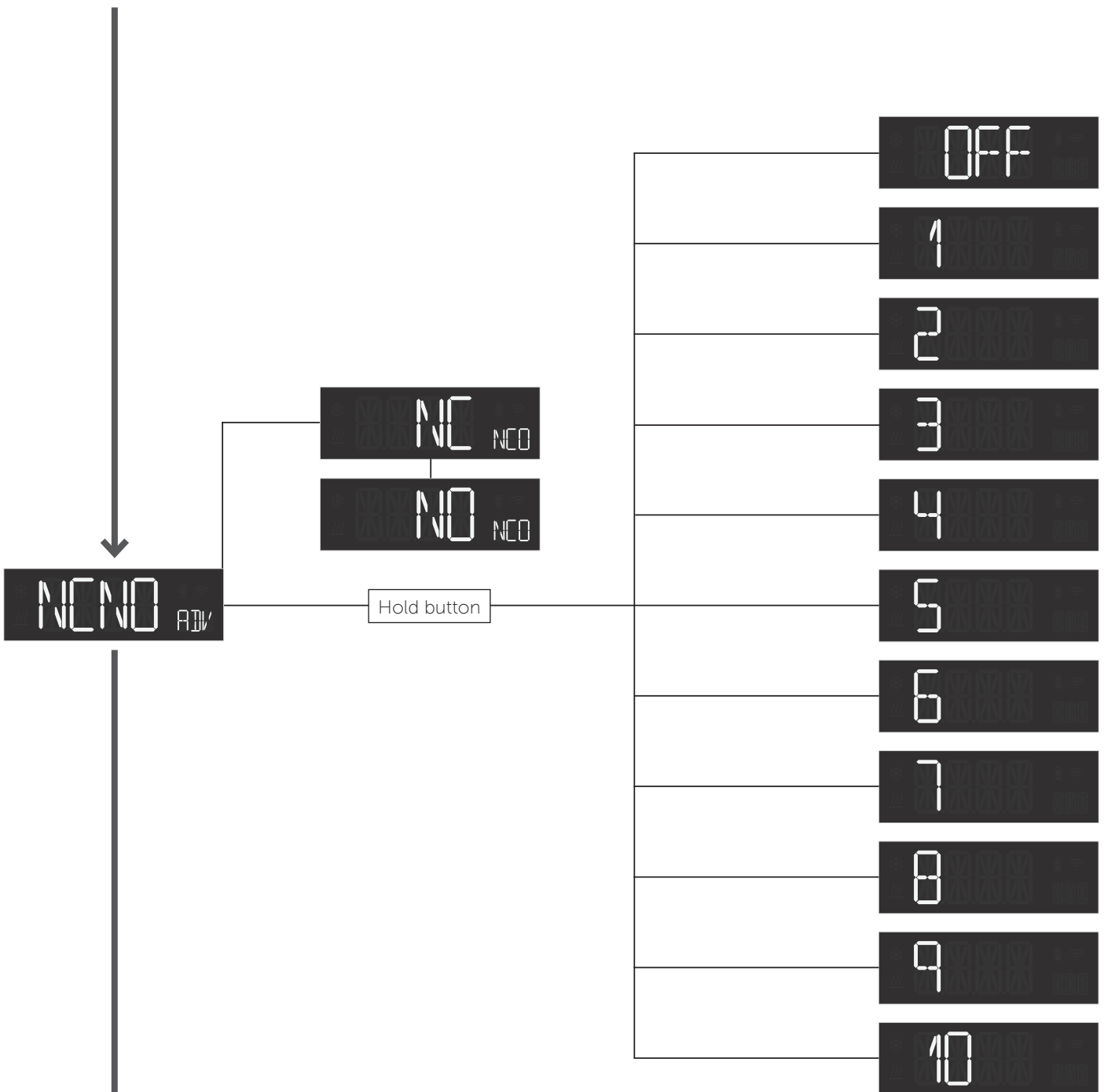
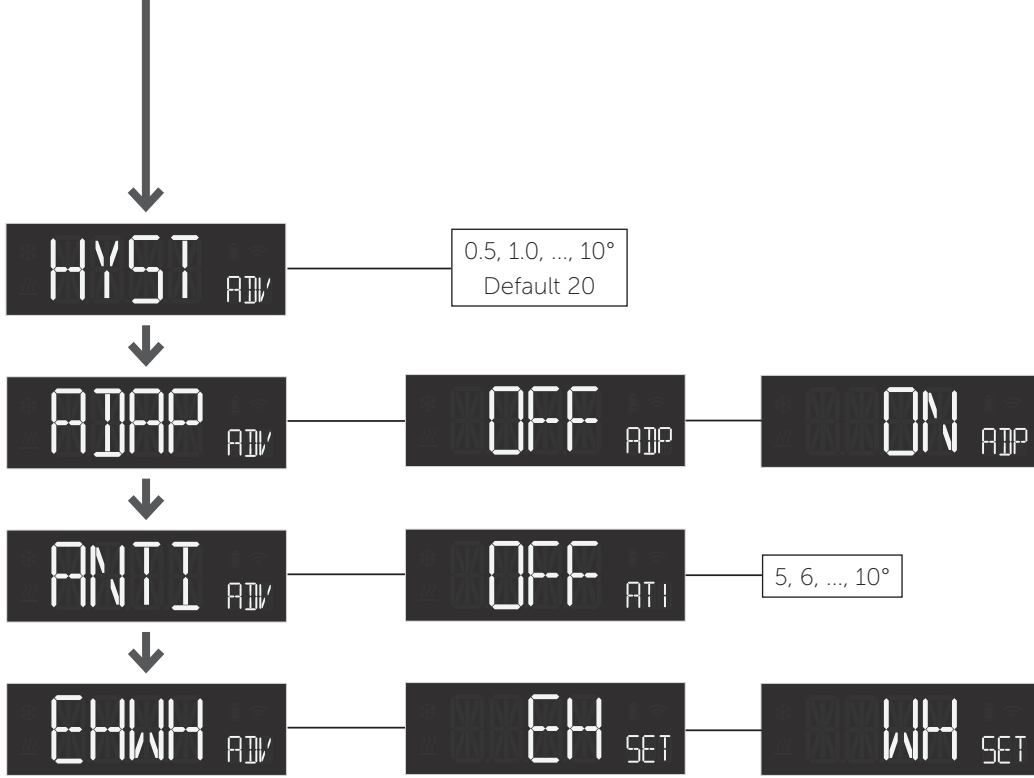

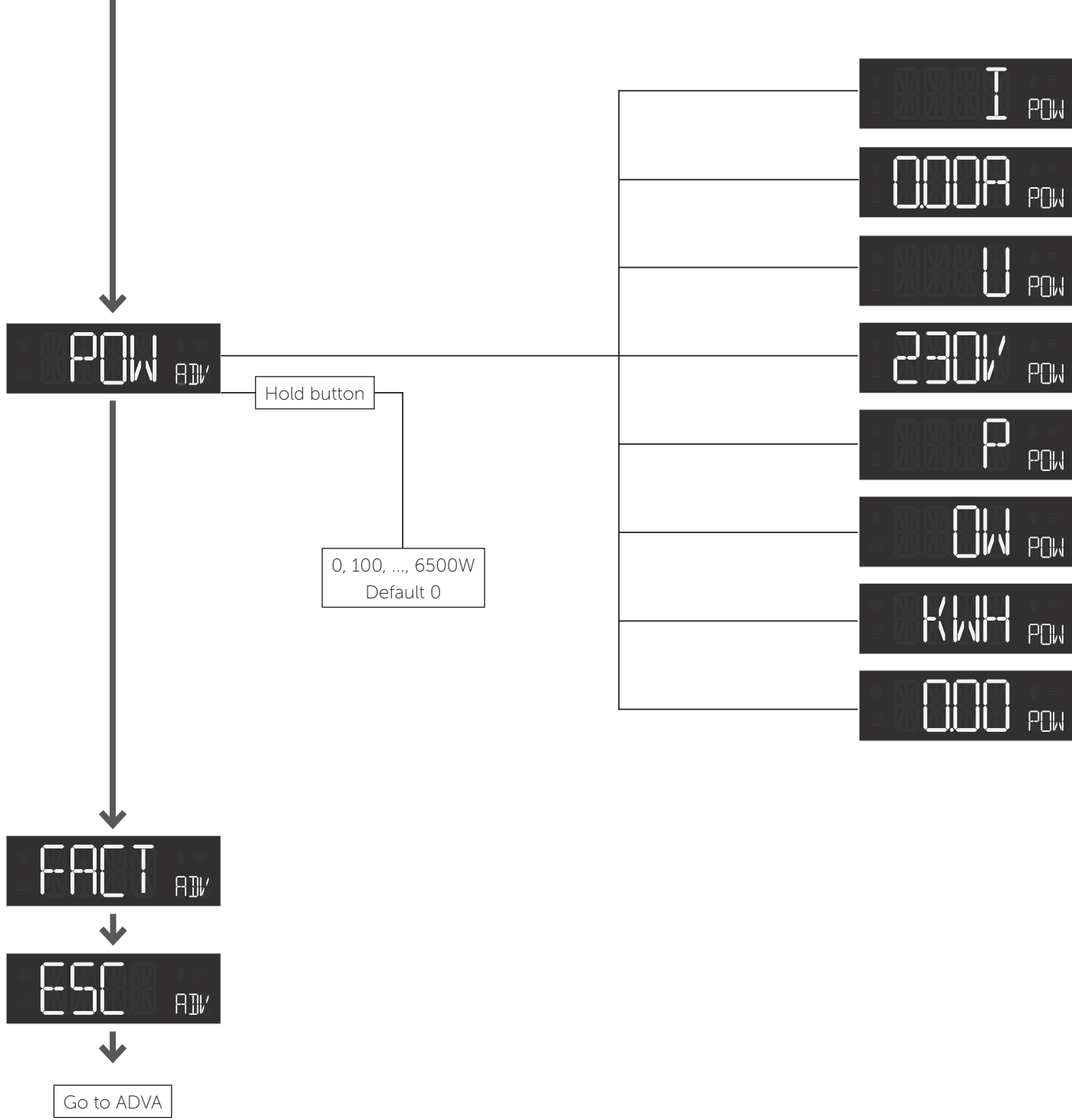











31.1 Error messages in display

	Internal error
	Internal sensor error
	Floor sensor error
	External sensor error
	Overheat
	Overload

31.2 General display messages

	Childlock activated
	Childlock disabled
	Backlight on when device in standby
	Backlight off when device in standby
	Settings stored

DISPOSAL GUIDELINES

Do not dispose of electrical appliances as unsorted municipal waste, use separate collection facilities. To prevent possible harm to the environment or human health from uncontrolled waste disposal, recycle it responsibly to promote the sustainable reuse of material resources. To return your used device, please use the return and collection systems or contact the retailer where the product was purchased. They can take this product for environmental safe recycling.

We have designed this product in accordance with our strict quality requirements (ISO 9001) and environmental requirements (ISO 14001). All electrical installations must be carried out by an authorized electrical installer. The product must be installed in accordance with our installers manual and national building codes. Any wrongful installation, misuse or damage to the product is not covered under warranty.

Heatit Controls AB can not be held liable for any type of errors or omissions in our product information. Product specifications may change without further notice.



PRODUCT INFO

Heatit Pro Thermostat

FEATURES

- Internal room sensor
- External room sensor (wired by cable)
- Floor sensor
- Temperature limiter
- 2 modes; Heat and Cool
- Hysteresis 0.5°C - 10°C
- Temperature calibration
- ZeroX detection
- Open window detection
- Relay status icon
- Adjustable display brightness
- Single pole switch
- Lock mode/child lock
- Anti-freeze
- Works with NO and NC actuators
- Weekly schedule
- Adaptive function
- Internal clock
- Backup battery for internal clock
- Active power metering

TECHNICAL DATA

Rated voltage	230VAC 50Hz
Max load	3600W (resistive load) Contactor recommended for loads above 13A
Max current	16A
Power consumption	<2W
Ambient temperature	5°C to 40°C
Temperature range	5°C to 40°C
Storage temperature	-30°C to 70°C
Hysteresis	0.5°C to 10°C (default 0.5°C)
Humidity	10% to 85% RH
Compatible with NTC-sensor with values	6.8, 10, 12, 15, 22, 33, 47 or 100kΩ @ 25°C
Length NTC sensor	Max. 15 meters
Screw terminals	Max. 2.5mm ² 2Nm
IP Code	IP21
Size (LxWxH)	84 x 84 x 52mm
Approvals	CE

MAINTENANCE

The device is maintenance-free. Indoor use only.

CONTROLS

Heatit Controls AB • Låkarvägen 4, 454 31 BRASTAD, SWEDEN

Phone: +47 61 18 77 77 • post@heatit.com • heatit.com